

Empowered by Innovation

NEC

NEC VERSA P8510 Series

Electronic User's Guide



Table of Contents	Page
Notebook Care	5
Introducing Your NEC VERSA	7
Introducing BIOS Setup for Windows Vista®	26
Windows Vista® Operating System Introduction	27
Notebook Components	34
Applications	35
Using Your NEC VERSA	47
Preparing for Travel	57
Using Peripheral Devices	60
Setting Up a Healthy Work Environment	62
Problem Checklist	68
Recovery Information for Windows Vista®	70
Frequently Asked Questions	75
Safety Notices	82
Glossary	89
License Agreement	90
Copyright	92
Trademarks	93
Official Name of the Software Used	94

About Your Electronic User's Guide

The illustrations, colours and pictures shown are for descriptive purposes. They may vary slightly from country to country and the unit you purchase. Please refer to the finished product for final configurations. Specifications and model names are subject to change without notice.



Note

You may find that your notebook is not supplied with devices/accessories that can be used with your available slots/connections/ports. This is because the notebook you have purchased has been fitted with a wide range of slots/connections/ports, to allow you greater flexibility and options should you decide later on to use external or optional devices/accessories.

Text Setup

To make this document as easy to use as possible, additional texts will appear throughout. The following details the layout and meaning of these additional texts.



Note

Notes give particularly important information about an item being described.



CAUTION

Cautions indicate situations that can damage the notebook hardware or software.



WARNING

Warnings alert you to situations that could result in serious personal injury or even loss of life.

*

*For specific models only

Items marked with an asterisk (*) denotes optional items only supplied for specific models. If the items are not found in the packaging box, it means that they are not applicable to the notebook you have just purchased, hence they are not included for you in the notebook.

Electronic User's Guide

This Electronic User's Guide aims to help you familiarise yourself with your new notebook. It contains more information on your notebook, the devices and applications associated with it, setting up a healthy work environment, safety notices and Windows®.

Visit our website at www.nec-computers-ap.com regularly to download the most up-to-date Electronic User's Guide and print it for your reference.



Note

We recommend that you print this documentation. It will then be easily accessible even when your notebook is shut down. To print the Electronic User's Guide, click "File" on the top menubar, and then click "Print" from the dropdown menu. You must have a printer installed and connected to be able to print.

Print in small booklets using recycled paper. Make two-sided prints and copies using the "duplex" function, print multiple images/page per page, and print only the quantity you need at the time you need it. This gives you a handy way to store the booklet nearby and saves paper.

Basic Care and Handling Tips

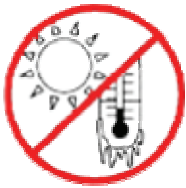

Protect the notebook from extremely low or high temperatures. Let the notebook warm (or cool) to room temperature before using it.



Keep the notebook away from magnetised areas (some airline tray tables are magnetic; do not set your notebook on top of them). Doing so may damage the data on your hard drive.



Keep the notebook dry. Do not wipe the notebook with a wet cloth or pour fluid onto it.



Protect the notebook from strong physical contact, such as being bumped or dropped.

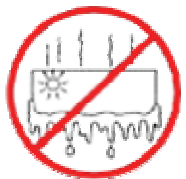

Check the notebook for condensation. If condensation is present, allow it to evaporate before switching on the notebook.



Keep the notebook away from dust, sand and dirt.



Note

For information on the specifications of your notebook, please refer to the **System Configuration Label** on the packaging box that comes with your system.



CAUTION

Before you connect or disconnect the power cords at the **AC port** of your notebook, please ensure that the power plug is disconnected from the AC power outlet.



WARNING

Do not place this notebook on your lap and/or allow it to be in contact with any part of your body while operating.

Notebook Care

Follow these guidelines to maintain the condition and performance of your notebook.



CAUTION

Immediately turn off and unplug the notebook under the following conditions:

- The power cord has been damaged or frayed.
- Liquid has spilled on or into the notebook.
- The notebook has been dropped or its casing has been damaged.

Precautions for Notebook Use

Take these precautions when using your notebook and AC adaptor:

- Be aware that your notebook may radiate heat when used for an extended period of time.
- Avoid dropping or bumping the notebook, or the AC adaptor.
- Do not stack heavy objects on the notebook, the AC adaptor, or the battery packs.
- Do not place items near the notebook that could block its air vents and cause overheating.
- Avoid moving the notebook during operation, especially while the hard disk, floppy disk, or optical disc drive is being accessed.
- When using the AC adaptor, make sure the power source falls within the notebook's compatibility range. Never use the AC adaptor if the voltage falls outside this range. Watch for this when travelling to other countries.
- Shut down the notebook before attaching or removing non-plug-and-play devices.
- Disconnect the notebook from its AC power outlet if it is not going to be used for a long time. This will avoid damage from transient over-voltage.
- Do not attempt to disassemble the notebook.
- Do not push any foreign objects into the notebook bays, connectors or slots.
- Keep the notebook away from magnetised areas (some airline tray tables are magnetic; do not set your notebook on top of them). Doing so may damage the data on your hard drive.
- Avoid using the notebook or AC adaptor for extended periods under direct sunlight.
- Do not use the notebook in humid or dusty environments.
- Keep liquids and food away from the notebook.
- Turn notebook power off before cleaning it.
- Avoid exposing the notebook or AC adaptor to extreme changes in temperature or humidity. If it is unavoidable, allow your notebook to adjust to room temperature before use.
- When cleaning the notebook, use a soft, clean, dry cloth. Avoid wiping the display surface with abrasive material, including rough fabric. Do not use a cleaning solution; this may damage the notebook's plastic surface.
- If the AC adaptor becomes extremely hot, unplug the adaptor and let it cool.

Be sure to follow these power cord safety tips:

- Unplug by gripping the plug only; do not pull on the cable.
- Place the power cord such that it cannot be tripped or stepped on, and do not place items directly on the power cord.
- Use an AC power outlet that is as close as possible to the notebook.

Storage Requirements

Store the notebook and AC adaptor in an environment that meets the following conditions:

Should the temperature of the notebook suddenly rise or fall (for example, when you move the notebook from a cold place to a warm place), vapour may condense inside the notebook. Turning on the notebook under such conditions can damage the internal notebook components.

Before turning on the notebook, wait until the notebook's internal temperature stabilises with the new environment and any internal moisture has evaporated.

- Operate and store your notebook within the recommended temperatures and humidity levels.

For more information, please refer to: **Safety Notices** → **Product Storage Environment Guidelines** in this Electronic User's Guide.

Page
88

- Keep the storage area free from vibration and magnetic fields.
- Keep the notebook and its components away from organic solvents or corrosive gases.
- Avoid leaving the notebook and its components under direct sunlight or near heat sources.

Routine Cleaning



CAUTION

Never use harsh solutions, household cleaners, or spray cleaners that contain caustic materials on the notebook. These cleaners are usually high in alkalinity, making them very corrosive. Using these cleaners can cause the notebook's plastic surface to crack or discolour.

Clean or dust your notebook as follows:

- LCD screen - carefully wipe the LCD screen with a soft cloth or special screen wipes designed for cleaning LCD screens. Special screen wipes are available from your local notebook dealer.
- Notebook case - we recommend that you carefully wipe the case with a slightly damp, soft cloth.

Introducing Your NEC VERSA

Getting to Know Your Notebook



WARNING

Prolonged or improper use of a computer workstation may pose a risk of serious injury. To reduce your risk of injury, set up and use your notebook in the manner described in the section on "Setting Up a Healthy Work Environment".

For more information, please refer to: **Setting Up a Healthy Work Environment** in this Electronic User's Guide.

**Page
62**

To get started, do the following:

- Read the section on "Setting Up a Healthy Work Environment" for guidelines that help you use your notebook productively and safely. Information includes setting up and using your notebook while reducing your risk of developing nerve, muscle, or tendon disorders.

For more information, please refer to: **Setting Up a Healthy Work Environment** in this Electronic User's Guide.

**Page
62**

- Read through this Electronic User's Guide to familiarise yourself with the notebook.

NEC VERSA

The notebook offers you a portable system filled with exciting resources for home, business or travel.



To settle in comfortably with your notebook, read the following sections and take a tour around your notebook!

The Front View of the Notebook

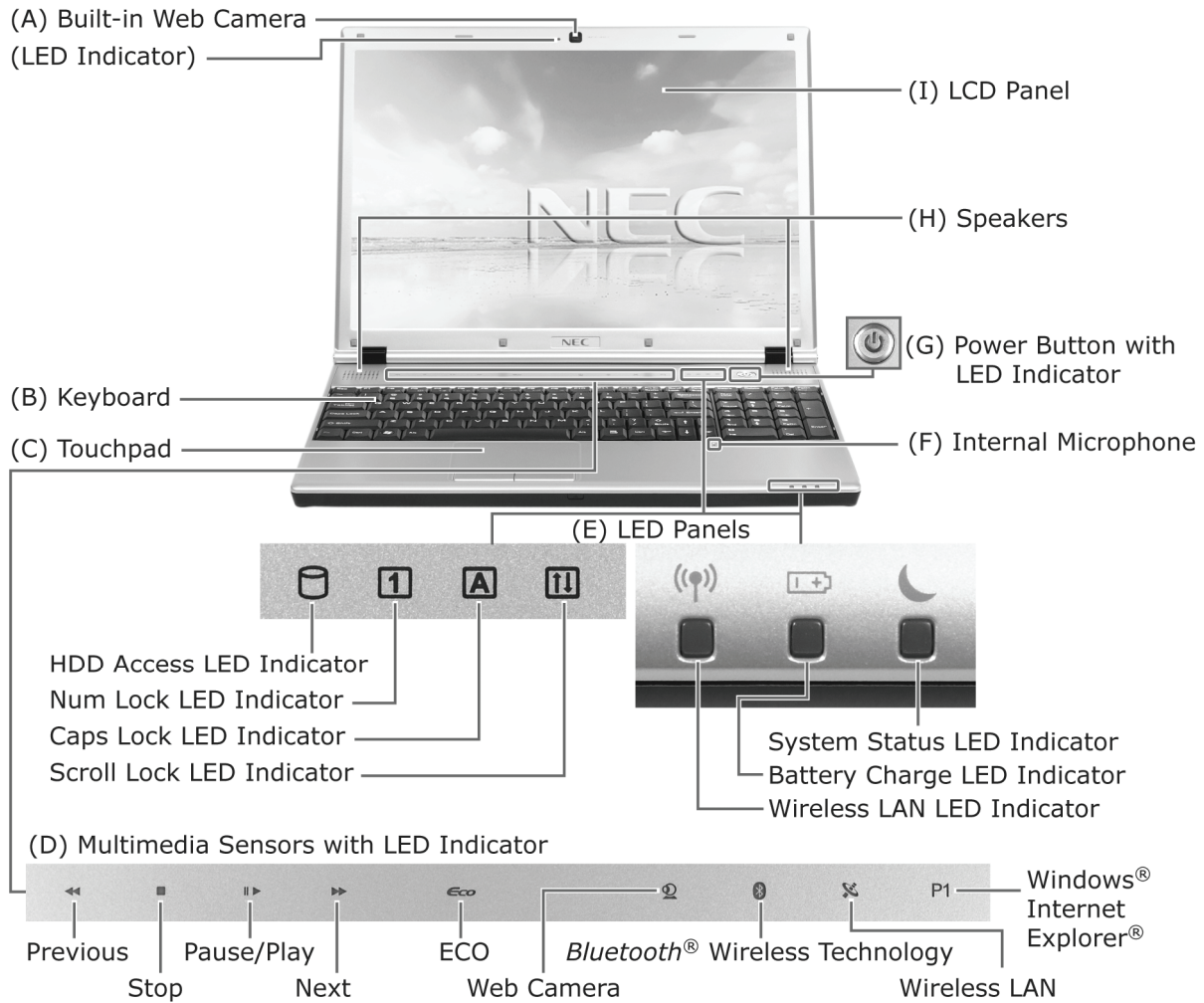



	Item	Description
A	Built-in Web Camera (LED Indicator)	For recording video or taking pictures. The CyberLink YouCam webcam application can be launched by double-clicking its icon  from the Windows® desktop. The LED Indicator will light up when the web camera is in use.
B	Keyboard	Standard QWERTY key layout (models purchased may be shipped with country-specific keyboard layouts).
C	Touchpad	Works like a standard computer mouse. Simply move your fingertip over the touchpad to control the position of the cursor.
D	Multimedia Sensors with LED Indicator	The multimedia sensors allow you to quickly execute commands or launch applications. <div style="background-color: #cccccc; padding: 5px; margin-top: 10px;"> For more information, please refer to: Introducing Your NEC VERSA → Multimedia Sensors with LED Indicator in this Electronic User's Guide. </div>
E	LED Panels	A panel of several LEDs which indicate various system conditions. <div style="background-color: #cccccc; padding: 5px; margin-top: 10px;"> For more information, please refer to: Introducing Your NEC VERSA → LED Behaviour in this Electronic User's Guide. </div>
F	Internal Microphone	Allows you to record sound with your notebook.

	Item	Description
G	Power Button with LED Indicator	Pressing this button switches on/off the notebook.
H	Speakers	Provides sound for your multimedia presentations or listening pleasure.
I	LCD Panel	A high resolution colour LCD display.

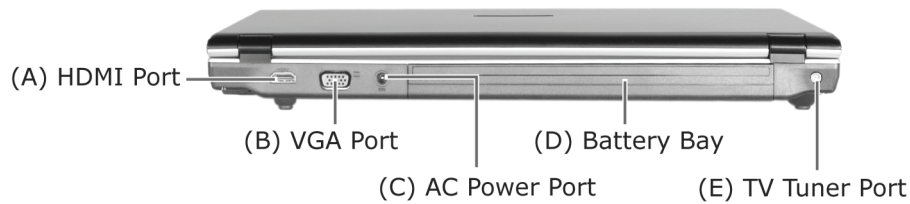
The Back View of the Notebook



	Item	Description
A	HDMI Port	Use this port to attach an external HD or digital monitor to your notebook.
B	VGA Port	Use this 15-pin port to attach an external VGA or analogue monitor to your notebook.
C	AC Power Port	Lets you attach the notebook to the AC Power source using the AC adaptor that comes with your notebook. Keep the notebook connected to AC Power whenever possible.
D	Battery Bay	Equipped with a rechargeable Lithium-Ion (Li-Ion) battery.
E	TV Tuner Port	<p>Although this port has been made available for your notebook, it is only intended for future use. Therefore, this port cannot be used at this time. This is due to the large variety of TV Tuner cards available in the market, and the various hardware compatibility issues caused.</p> <p> WARNING This port cannot be removed. Do not attempt to use or connect with an antenna or any other devices. This is to prevent possible short circuits, damage to your notebook</p> <p> WARNING Should you add a TV tuner on your own, please be warned that an incompatible TV tuner exposes you to the following risks:</p> <ul style="list-style-type: none"> i) The computer could overheat if the TV tuner is too hot during operation ii) There is a lightning surge danger should you connect it to an outdoor antenna during a thunderstorm.

The Left Side View of the Notebook

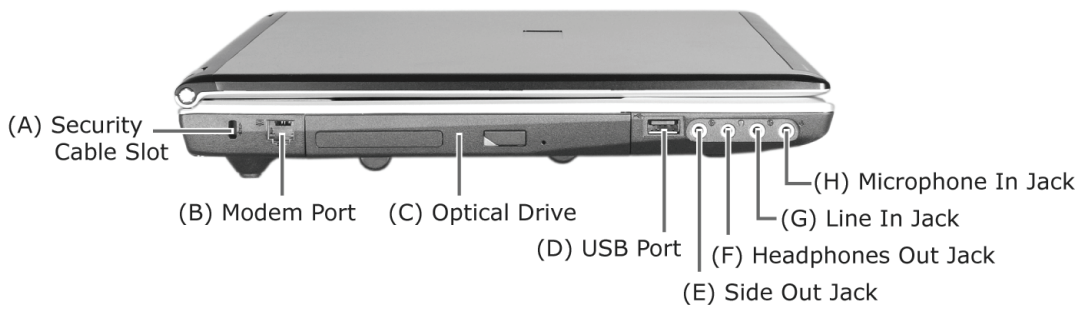

	Item	Description
A	Security Cable Slot	This slot is for fitting a security cable device for extra protection of your notebook from theft, by physically securing it to a stationary object such as a table or grill.
B	Modem Port	Use this port to connect the notebook to an analogue telephone line for access to the internet.
C	Optical Drive	The optical drive that comes with your notebook depends on the configurations of the purchased notebook. Typically, your optical drive should be able to access most common optical discs such as CDs and DVDs.
D	USB Port	Each USB port allows you to connect USB-equipped peripheral devices such as printers, monitors and scanners to your notebook.
E	Side Out Jack	Allows you to use 7.1 channel surround speaker systems used in home entertainment systems.
F	Headphones Out Jack	Lets you plug in stereo headphones or external speakers. These will convert audio output from the notebook into sound or music, usually for multimedia enjoyment.
G	Line In Jack	Allows your notebook to receive audio signals from a cassette tape recorder or similar sound source.
H	Microphone In Jack	Allows you to connect an external microphone. This will transmit sound to your notebook, usually for recording or amplifying with speakers.

The Right Side View of the Notebook

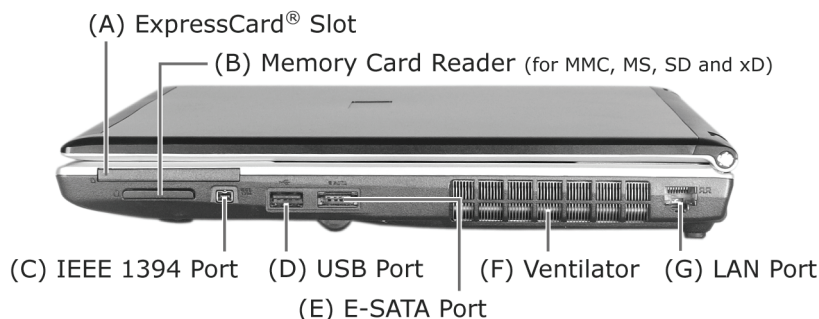

	Item	Description
A	ExpressCard® Slot	Allows you to insert an ExpressCard®. This card is a hardware interface that replaces PC cards, allowing you to accept many types of external hardware such as external disk drives, TV tuner cards and additional memory.

	Item	Description
B	Memory Card Reader	This port allows you to read data from different types of memory cards: MMC, MS, SD and xD.
C	IEEE 1394 Port	Use this port to daisy chain up to 63 IEEE 1394 (a high-speed interface) devices to your system. IEEE 1394 devices support plug-and-play connectivity for transfer rates of up to 400 MB/s.
D	USB Port	Each USB port allows you to connect USB-equipped peripheral devices such as printers, monitors and scanners to your notebook.
E	E-SATA Port	Use this port to connect to an E-SATA hard disk drive.
F	Ventilator	This provides ventilation, to ensure your notebook's temperature is optimal.
G	LAN Port	Connects to a network cable, allowing your notebook to communicate with other devices over a network, such as via the Internet.

The Bottom View of the Notebook

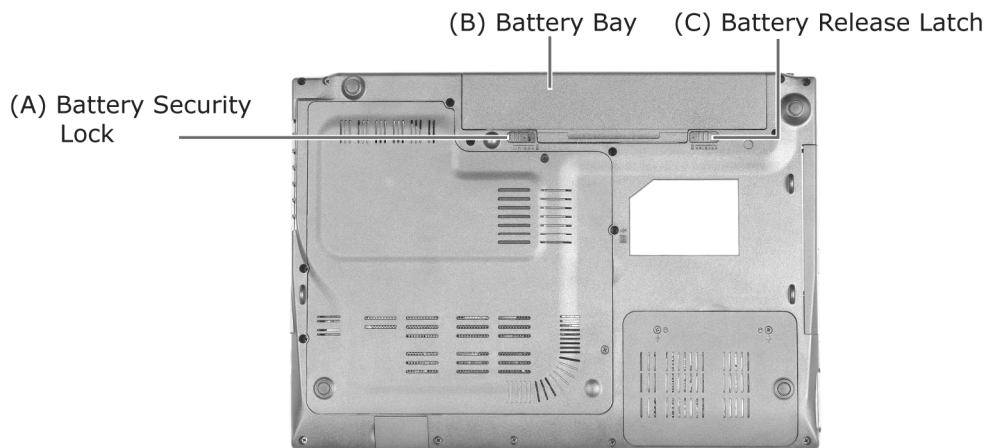

	Item	Description
A	Battery Security Lock	Secures the battery inside the battery bay. For more information, please refer to: Introducing Your NEC VERSA → Replacing the Battery in this Electronic User's Guide. Page 23
B	Battery Bay	Equipped with a rechargeable Lithium-Ion (Li-Ion) battery.
C	Battery Release Latch	Releases the battery from the battery bay. For more information, please refer to: Introducing Your NEC VERSA → Replacing the Battery in this Electronic User's Guide. Page 23

Keyboard

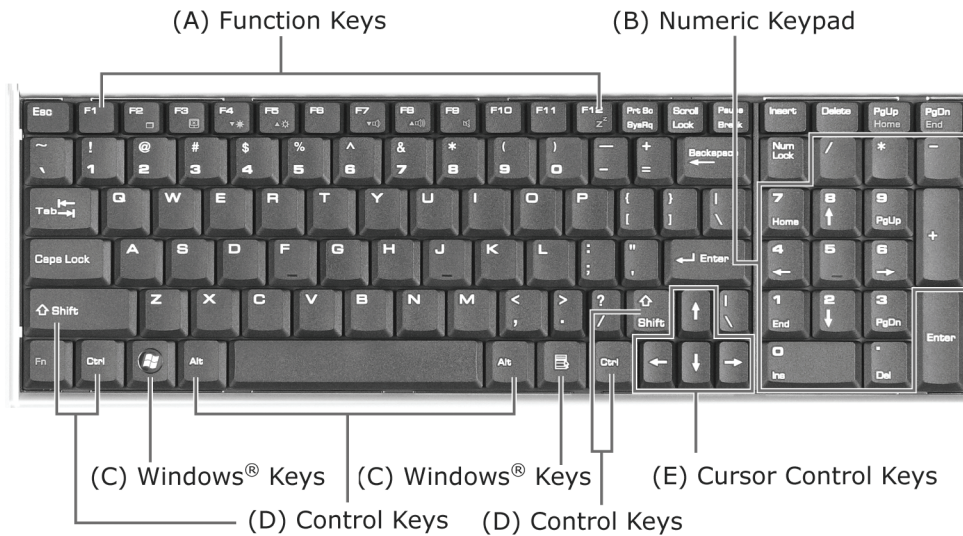

The keyboard is equipped with many features. However the outlook of the keyboard may be slightly different from your actual unit. These include:

- **Function Keys (A)** - function keys are available on the notebook keyboard. These keys work together with the **Fn** key to activate special functions. Function keys are application-driven.

For more information, please refer to: **Introducing Your NEC VERSA** → **Function Keys** in this Electronic User's Guide.











Page
17

- **Numeric Keypad (B)** - pressing **Fn+Num Lock** on the keyboard activates the numeric keypad numbers and functions printed in blue at the bottom right corner of the keys. The keypad lets you type numbers and mathematical operators (+, -) as you would on a calculator. The keypad is ideal for entering long lists of numbers. When you press **Fn+Num Lock** again, the keys revert to their normal functions as typewriter keys.
- **Windows® Keys (C)** - use the following two keys to facilitate your work.
- **Control Keys (D)** - **Ctrl**, **Alt**, **Fn** and **Shift** are controls used in conjunction with other keys to change their functions. To use control keys, press and hold down the control key while pressing another key. For example, "Press **Ctrl+c**" means to hold down the **Ctrl** key and press the **c** key. Key combinations are specific to the application you are running.

	Shortcut/Application key - provides quick access to shortcut menus. (This key acts like a mouse's right-click button.)
	Floating Windows® key - displays the Start menu. (The outlook of the Floating Windows® key depends on the notebook you purchase.)









- **Cursor Control Keys (E)** - cursor control keys let you position the cursor on the screen. On the screen, the cursor is a blinking underline, block, or vertical bar depending on the application. The cursor indicates where the next typed character/text will be inserted.

LED Behaviour

	Item	Description	
	HDD Access LED Indicator	Blue	Indicates that the notebook is accessing the hard disk drive.
	Num Lock LED Indicator	Blue	Indicates that Num Lock is activated.
	Caps Lock LED Indicator	Blue	Indicates that Caps Lock is activated.
	Scroll Lock LED Indicator	Blue	Indicates that Scroll Lock is activated.
	Battery Charge LED Indicator	Off	Indicates that notebook battery is full and is running on AC power.
		Dual Colour (Yellow-Green)	Indicates that the battery is charging.
		Blinks Dual Colour (Yellow-Green)	Indicates that there is a battery error.
		Red	Indicates that the battery is low.
	Note The battery may be overheating and therefore cannot start charging. Disconnect the AC adaptor from the wall outlet and allow both the notebook and battery to cool to room temperature.		
	Note Connect the AC adaptor cable into the power port on the notebook when the battery is in warning or low status.		
	CAUTION Before you connect or disconnect the power cable at the AC port of your notebook, please ensure that the power plug is disconnected from the wall outlet.		
	Wireless LAN LED Indicator	Blue	Indicates that Wireless LAN is On.
	System Status LED Indicator	Off	Indicates that the notebook is switched Off/Hibernate.
		Blue	Indicates that the notebook is powered on.
		Blinks Blue	Indicates that the notebook is in Sleep mode.
	Power Button LED Indicator	Blue	Indicates that the notebook is powered on.

Multimedia Sensors with LED Indicator

The multimedia sensors allow you to quickly execute commands or launch applications. To use them, simply tap lightly on the icon to execute the command or launch the application associated with it.

	Function	Description
	Previous	Tap this icon once to return to the Previous content.
	Stop	Tap this icon once to Stop the playback of the active media.
	Pause/Play	Tap this icon once to Pause the playback of the active media. Tap this icon again to Play or resume the playback of the active media.
	Next	Tap this icon once to go to the Next content.
	ECO	Tap this icon once to turn On/Off " ECO " settings. This is a power saving mode.
	Web Camera	Tap this icon once to turn On/Off the Web Camera .
	Bluetooth® Wireless Technology	Tap this icon once to turn On/Off the Bluetooth® Wireless Technology .
	Wireless LAN	Tap this icon once to turn On/Off the Wireless LAN .
	Windows® Internet Explorer	Tap this icon once to turn On/Off the Windows® Internet Explorer application. This is programmable.

To program the P1 sensor:

1. Locate "System Control Manager" icon at System Tray.



2. Right click on the icon, and select "User-Defined Key".

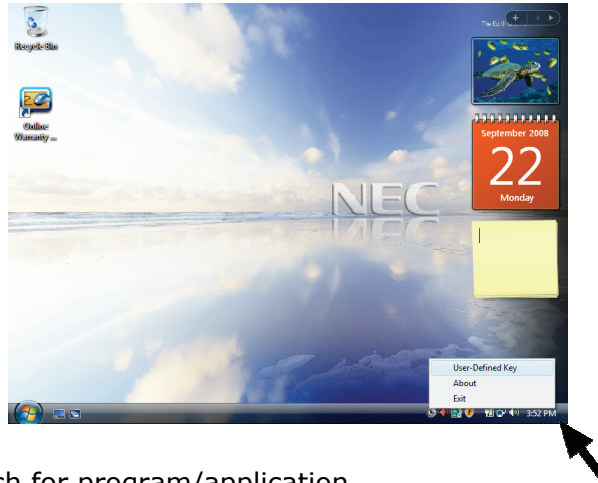

3. Click "Browse" to search for program/application.

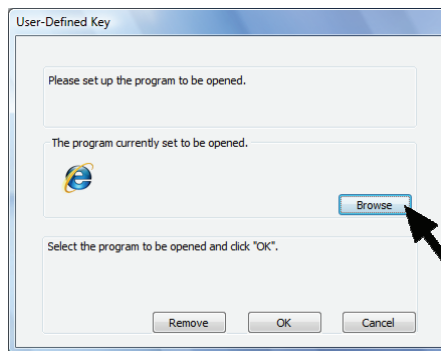

4. Select your favorite program/application and click Open.

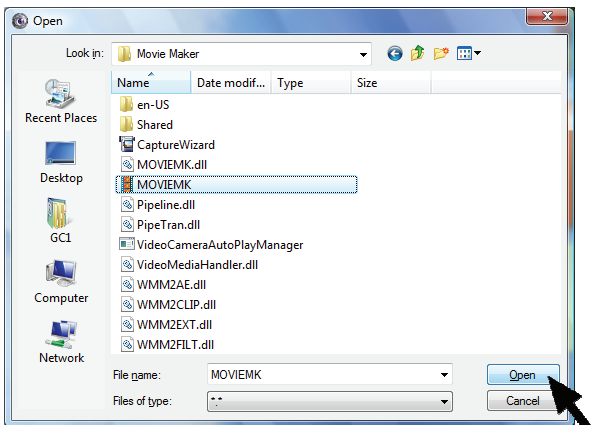

For English language operating system

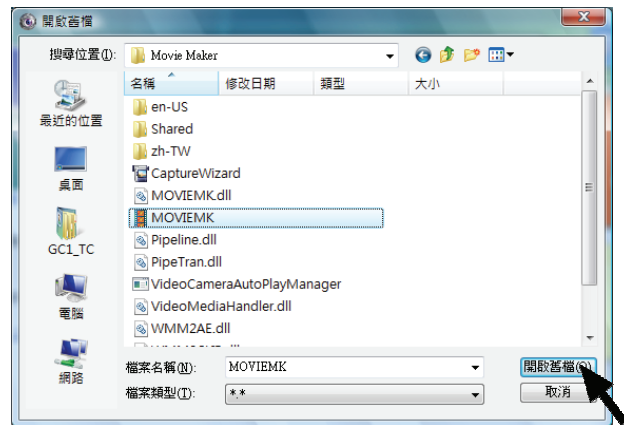

For Traditional Chinese operating system

5. Click "OK" to confirm the changes.

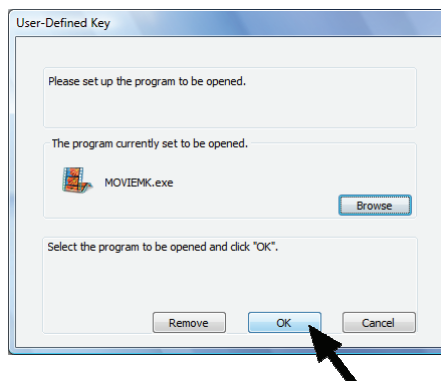

Function Keys

Function keys are available on the notebook keyboard. These keys work together with **Fn** key to activate special functions. Function keys are application-driven.

The following function key combinations are pre-programmed for the notebook.

Keys	Function	Description
Fn + F2	Display Device	Switches between display devices, such as an external monitor or projector.
Fn + F3	Enable/Disable Touchpad	Enables/Disables the touchpad. You can enable the touchpad for increased mobility or disable it when using an external mouse.
Fn + F4	Brightness Down	Lowers the brightness of your screen display. Each press lowers the brightness by one level.
Fn + F5	Brightness Up	Increases the brightness of your screen display. Each press increases the brightness by one level.
Fn + F7	Speaker Volume Down	Lowers the volume of your sound/audio system. Each press lowers the volume by one level.
Fn + F8	Speaker Volume Up	Increases the volume of your sound/audio system. Each press increases the volume by one level.
Fn + F9	Mute	Switches the audio/sound to mute. This is to switch off sound without interrupting playback of media.
Fn + F12	Sleep	Enables the Sleep mode. Pressing this tells the notebook to go into standby, shutting down disk activity and lowers energy consumption.

Power Button

Use the Power button in the following ways:

- Press the Power button to power on.
- Press the Power button to move from Standby mode and to proceed with normal operations.
- Press and hold the Power button in place for 4 or more seconds to initiate power override (powers off the notebook). Only use this option if you cannot power off your notebook using the normal procedure.

Put the unit in Standby mode when you need to be away from your notebook for a short period of time and want to return to where you left off. Standby mode shuts down all devices in the notebook while retaining data and notebook status.

For more information, please refer to: **Windows Vista® Operating System**
Introduction → **Managing System Power** in this Electronic User's Guide.

Page
31

Optional Accessories

For more information on accessories, please refer to or contact to the local sales representative near you.

Using the Touchpad

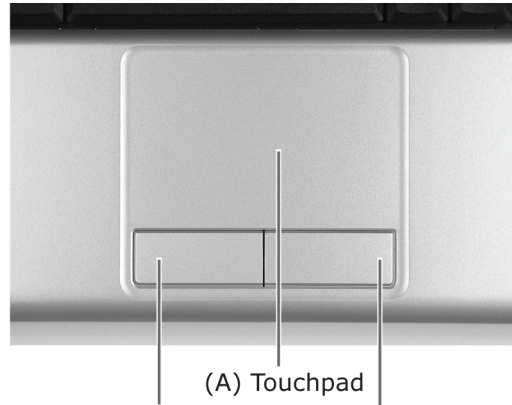

(A) Touchpad (B) Left Click Button (C) Right Click Button

The touchpad is an easy way to control the cursor with your finger. Lightly glide your finger across the touchpad and the cursor will replicate your movement on the screen.

To use the touchpad, you can:

- Single tap the touchpad, or single click on the left button, equivalent to a single click of the primary mouse button.
- Double tap the touchpad, or double click on the left button, equivalent to a double click of the primary mouse button.
- Click the left button and hold, then drag your finger across the touchpad, equivalent to a click and drag of the primary mouse button.

	Item	Description
A	Touchpad	This device replaces the mouse and is for positioning the cursor on a notebook display screen.
B	Left Click Button	This is the primary button. Clicking it usually selects the item your cursor is pointing at.
C	Right Click Button	Clicking this button usually opens a menu of options available for the item currently selected.

If you find the double tap difficult to use, go to the next section for general directions about adjusting the touchpad properties.



Note

If you install another mouse driver over the shipping default, the double-tap capability may be lost.

Touchpad Tips

Follow these basic ergonomic tips while working:

- Use a light touch on the touchpad surface.
- Set up the notebook with your keyboard and touchpad at a comfortable height. Keep your forearms parallel to the floor. Your wrists should be relaxed and straight.
- While using the keyboard and touchpad, keep your shoulders and arms as relaxed as possible.
- Take regular breaks from the notebook to rest your eyes. Perform stretching exercises to relax your fingers, hands, wrists, forearms and shoulders.

Power Sources

The notebook can be powered using two different sources, making it a truly portable system. Operate your notebook just about anywhere using one of the following power sources:

- The AC adaptor connected to an AC power outlet (usually on a wall).
- The battery pack.

For more information, please refer to: **Introducing Your NEC VERSA → Using the Battery** in this Electronic User's Guide.

Page
21

Read the following sections for specific information about using the power sources.

AC Adaptor

Use the AC adaptor and power cable that come with your notebook to run your notebook on AC power, or to recharge the battery pack. Use the AC adaptor whenever an AC power outlet is nearby.

Keep the adaptor connected whenever possible. The AC adaptor charges the battery when it is connected, whether the notebook is powered on or off.

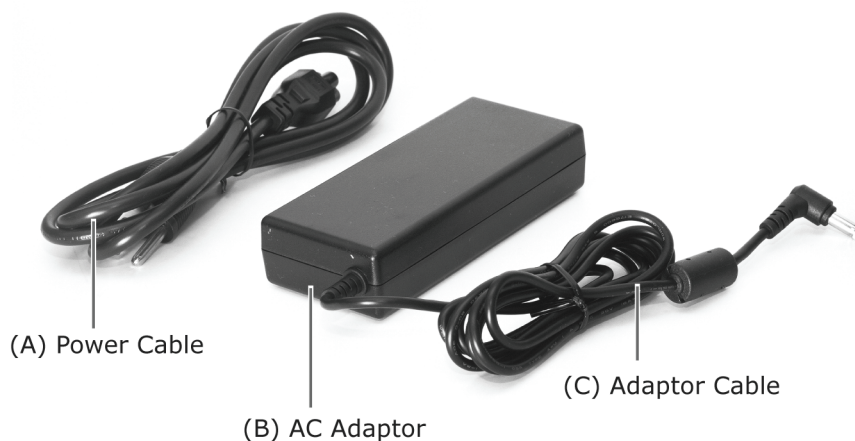

Note

The power cable may vary from country to country.



Note

Consult your dealer or the local electrical authorities if you are unsure of the type of power cord to use in your country. Failure to use the correct power cord/cable may result in electrical shock.



WARNING

Do not attempt to disassemble the AC adaptor. The AC adaptor has no user-replaceable or serviceable parts inside. Dangerous voltage in the AC adaptor can cause serious personal injury or death. The AC adaptor is intended for use with a notebook and must meet EN609050 standards.

Connecting the AC Adaptor

Connect the AC adaptor as follows:

1. Connect the AC adaptor cable into the power port on the notebook.
2. Plug one AC adaptor cable into the adaptor.
3. Connect the AC adaptor cable to grounded 100- or 240-volt, 50- or 60-Hz AC power outlet.

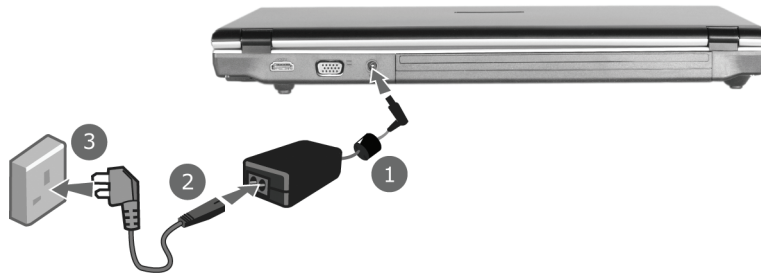

CAUTION

- Do not cover or place objects on the AC adaptor. Keeping the adaptor clear of objects lets the adaptor cool properly during use.
- Only use the AC adaptor that comes with your notebook. Although other adaptors look similar, using them can damage your notebook.



CAUTION

This equipment uses an ungrounded power cable. Replace the cord if it becomes damaged. The cord must be rated for at least 250VAC at 10 amps, and must indicate international safety agency approval. The plug must be a type appropriate for the country where it is used. Check with your local dealer for HAR (Harmonisation certification mark) type 18 AWG (American Wire Gauge), 2 conductor cord, or better. Obtain replacement cords at an authorised service centre. The replacement must be of the same type and voltage rating as of the original cord.

Using the Battery



Note

Although the battery is fully charged at the factory, transit and shelf time may reduce the initial battery charge. We recommend that the first time you use your notebook, you connect it to AC power using the AC adaptor. This also recharges your battery.

When the battery capacity is low, always respond by immediately saving your data, and connecting your notebook to the AC adaptor. If an AC adaptor is not available, change the battery using the battery replacement procedure.

For more information, please refer to: **Introducing Your NEC VERSA → Replacing the Battery** in this Electronic User's Guide.

Page
23

If you do not take any action, the notebook will automatically go into Hibernation (Save To File) mode.



WARNING

To prevent accidental battery ignition or explosion, adhere to the following:

- Keep the battery away from extreme heat.
- Keep metal objects away from the battery terminals to prevent a short circuit.
- Make sure the battery is properly installed in the battery bay.
- Read the precautions printed on the battery (if any).
- Remember to unplug the AC adaptor cable from the power port on the notebook and from the grounded AC power outlet after your notebook is fully charged, when your notebook is not in use or when you know that your notebook will be unattended for long hours.
- Do not disassemble the battery.

Charging the Battery

Charge time depends on whether or not you are using the notebook.

For maximum battery performance, fully discharge the battery before recharging it. To do so, unplug the AC adaptor, turn off power management features (through BIOS Setup and Windows® power management), and turn on the notebook. Once the battery is fully discharged, plug in the AC adaptor and recharge the battery.

Precautions for Recharging the Battery

- Adhere to the following precautions when recharging the battery.
- Use only the battery charger designed for your notebook battery type. Different NEC VERSA models require different batteries and battery chargers.
- Charge the battery for the specified charge time only.
- During charging, keep the environmental temperature between 5°C and 35°C.
- Read the instructions that come with the battery charger before charging the battery.

Low Battery Power

When battery power gets low, connect your notebook to the AC adaptor.

If no AC adaptor is available, change the battery using the battery replacement procedure.

For more information, please refer to: **Introducing Your NEC VERSA → Replacing the Battery** in this Electronic User's Guide.

Page
23

Conserving Battery Power

The battery performance is affected by the following conditions:

- When it is new and fully charged.
- When no peripherals are connected to your notebook.
- When you have no options installed.

While on the road, it is important to be aware of the simple things you can do to extend the life of the notebook's main battery. For instance, turning down the screen brightness (specific function key) extends battery life.

Power Management Features

Enabling power management features increases battery life.

The Hibernate power management state, also known as Save-To-File (STF), saves the notebook's current working environment to the notebook's hard drive, then powers down the notebook to conserve battery power. You can configure your power management settings to enter hibernation when your notebook reaches a critical low battery stage.

For more information, please refer to: **Windows Vista® Operating System Introduction → Managing System Power** in this Electronic User's Guide.

Page
31

Battery Precautions

To prevent accidental battery ignition, rupture, or explosion, adhere to the following precautions.



WARNING

There is a danger of explosion if the battery is incorrectly replaced. Replace only with the same or equivalent type recommended by the manufacturer. Discard used batteries according to the manufacturer's instructions.

To avoid personal injury and property damage, read these battery precautions on handling, charging and disposing batteries:

- Keep the battery away from heat sources including direct sunlight, open fires, microwave ovens and high-voltage containers. Temperatures over 60°C may cause damage.
- Do not drop or impact the battery.
- Do not solder the battery.
- Do not puncture the battery.
- Do not use a battery that appears damaged or deformed, has any rust on its casing, is discoloured, overheats, or emits a foul odour.
- Keep the battery dry and away from water.
- Keep metal objects away from battery terminals. Metal objects in contact with the connectors can cause a short circuit and subsequently damage the battery.

If the battery leaks:

- If the battery leaks onto skin or clothing, wash the area immediately with clean running water. Battery fluid can cause skin rashes and damage fabric.
- If battery fluid gets into the eyes, DO NOT RUB. Rinse with clean water immediately and seek professional medical assistance.
- Take extra precautions to keep a leaking battery away from fire. There is a danger of ignition or explosion.

Replacing the Battery

This section describes how to remove and replace the primary battery.



WARNING

To prevent accidental battery ignition or explosion, strictly adhere to the following:

- Keep the battery away from extreme heat.
- Keep metal objects away from the battery terminals to prevent a short circuit.
- Make sure the battery is properly installed in the battery bay.
- Read the precautions printed on the battery (if any).

Removing the Battery in your Notebook



CAUTION

Be sure to save your data before replacing the battery pack or connecting the AC adaptor. Failure to do so can result in data loss.



Note

Place your notebook in this position and follow the steps stated to remove the battery.

	1	Save your files, exit Windows®, and turn off system power.
	2	Close the LCD panel and turn the system over. CAUTION Be extra careful to avoid damage to your notebook
	3	Unlock the battery security lock.
	4	Hold the latch to the "Unlock" position.
	5	Slide the battery outwards to remove the battery.

Installing the Battery in your Notebook

Insert the new battery as follows:



Note

Place your notebook in this position and follow the steps stated to install the battery.

	1	Turn the notebook over. CAUTION Be extra careful to avoid damage to your notebook.
	2	Make sure you unlock the battery security lock.
	3	Align the battery with the battery bay slot and connector.
	4	Place the battery into the battery bay. Carefully press and secure the battery into the battery bay.
	5	Make sure you lock the battery security lock.

Handling the Battery

Review the following before handling the notebook battery.



CAUTION

Only use the type of battery specifically designed for the notebook. Using other NEC VERSA batteries, other manufacturer's batteries, or using a combination of very old and new batteries can cause battery and equipment performance to deteriorate.

Turn off the notebook power after use.

- Clean the battery connectors with a dry cloth if they get dirty.
- When not in use, store the battery in a cool dry area.

The following symptoms indicate that battery life is nearing an end. Discard batteries that display these symptoms:

- Shorter work times.
- Discolouration, warping.
- Hot to the touch.
- Strange odour.

Disposing of the Battery

Before disposing of the battery, put adhesive tape on the connectors. Contact your local waste management officials for information regarding environmentally sound collection, recycling and disposal of batteries.

Introducing BIOS Setup for Windows Vista®

A hardware program called **BIOS Setup** allows you to view and set system parameters. **BIOS Setup** also allows you to set password features that protect your notebook from unauthorised use.

Use **BIOS Setup** to:

- Set the current time and date.
- Customise your operating system to reflect your notebook hardware.
- Secure your notebook with a password.
- Balance your performance needs with power conservation.

Entering BIOS Setup

The **BIOS Setup** can be accessed during the startup or booting of your notebook. Just press **<F2>** when the following prompt appears.

"Press <F2> to run CMOS Setup or <F12> to Boot on Network"

When you press **<F2>** to enter **BIOS Setup**, the system interrupts the Power-On Self-Test (POST) and displays the current complementary metal-oxide semiconductor (CMOS) RAM settings.

If the system detects an error during POST, it prompts you with a double beep and the message: "Press **<F1>** to resume." If you press **<F2>**, the system enters **BIOS Setup** automatically. If you want to fix the error, carefully read the error message that appears above the prompt (taking notes if you want), and press **<F2>**. You will see this message if your system's CMOS battery (which provides power to maintain system configuration settings) has become fully discharged.

BIOS Setup Menus

The **BIOS Setup** features five menus, which are listed on the menu bar at the top of the screen.

Main - use this menu for basic system configuration.

Advanced - use this menu to control system ports and components.

Security - use this menu to establish system passwords and protect the boot sector of the hard disk drive against infection by certain virus types.

Boot - use this menu to set the boot sequence.

Exit - use this menu to exit BIOS Setup with various save or discard options.

Use the keys listed in the legend bar on the bottom of the Setup menu to make the selections or exit the current menu.

The exact menu may be different from the notebook you purchase depending on the mainboard type.

Windows Vista® Operating System Introduction

The operating system is the most important program that runs on a computer. Every computer must have an operating system to run other programs. Operating systems perform basic tasks, such as recognising input from the keyboard, sending output to the display screen, keeping track of files and directories on the disk, and controlling peripheral devices such as disk drives and printers.

Windows Vista® Operating Systems

The Windows Vista® operating systems provide a means of running applications, navigating through your file structure, and using your notebook. Each operating system offers its own look and tools through an easy-to-use graphical interface.

Windows Vista® Operating System Setup

For Windows Vista® Operating system setup

When you switch on the notebook, the message "©Microsoft Corporation" will be displayed. Please wait a while for the **First page of set up Windows®** screen to be displayed.



Note

The procedure described below applies to systems featuring LAN capabilities. Some of these screens may otherwise not appear.

IMPORTANT NOTICE

For Hong Kong dual boot models (2 languages, that is in English and Traditional Chinese), please refer to: **Windows Vista® Operating System Introduction** → **Dual boot** in this Electronic User's Guide.

Page
28

1: Initial Windows® setup screen.

Choose your appropriate Country or Region, Time and Currency, and Keyboard Layout. Then click the **Next** button at the lower right corner.

2: The End User License Agreement screen.

Carefully read the license agreement and click in the relevant check box to accept its terms. Click the **Next** button.

3: Username and picture selection screen.

Enter a username and password (optional) and also choose a picture at the bottom of the screen to represent your user account. Click the **Next** button.

4: Notebook name and desktop background selection screen.

Enter a notebook name then choose a desktop background from 6 options available at the bottom of the screen. Click the **Next** button.

5: Helping protect Windows® automatically screen.

There are 3 options available; read each description and click your preferred option.

6: Time and date settings screen.

Choose and set appropriate Time Zone, Date and Time. Click the **Next** button.

7: Notebook's current location screen.

This page only appears if your notebook is connected to a network. There are 3 options available; read each description and click your preferred option.

8: Thank you! screen.

Click the **Start** button to complete the Windows Vista® operating system installation.

Dual Boot (2 languages – English and Traditional Chinese)

*For Hong Kong dual boot models only

There are 2 language versions of the Windows Vista® operating system available on this notebook, that is, in English and Traditional Chinese. When you start your notebook for the first time, you are required to choose either one of the operating system languages you prefer (please refer to the screen illustration below).

IMPORTANT

Please select the language you prefer carefully as this can only be done once.

You will see the message "©Microsoft Corporation" displayed on your screen. Please wait for a moment while the initial Windows® setup screen loads.

For more information, please refer to: **Windows Vista® Operating System Introduction** → **Windows Vista® Operating System Setup** in this Electronic User's Guide.

Page
27

IMPORTANT

Windows® Language Selection

*This option is applicable to Hong Kong dual boot models only.

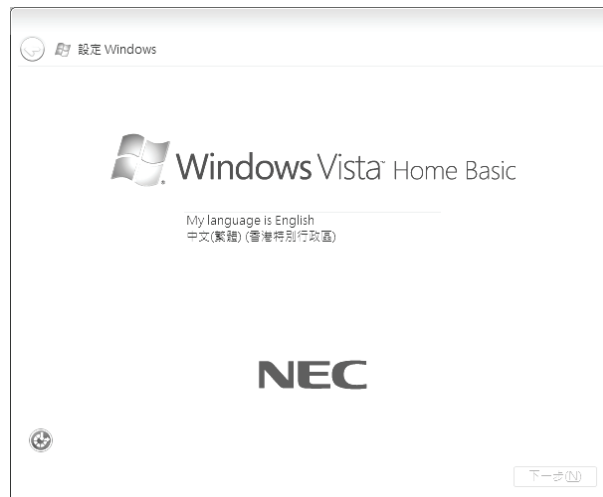

CAUTION

Once you have selected the language you prefer, your operating system will be installed with the selected language permanently. You will not be able to change this selection for the operating system language.

Referring to the guide provided above, please follow the on screen instructions accordingly.

Windows Vista® Operating System

Windows Vista® operating system features include a Desktop with room to manoeuvre, a taskbar for quick access to a variety of system functions, state-of-the-art plug-and-play support, powerful system utilities, enhanced entertainment features and a fully integrated Internet experience.

Among the new features are:

Windows® Explorer – Windows® Explorer has also had its functionality expanded. Explorer windows now are 3-paned, with extra information and functionality in the middle window.

Preview Applet – For viewing and editing images. An enhanced Preview Applet is included that lets you view, zoom in and out, rotate, print, save (as), and delete images. This is supported by the Windows® Bitmap, JPEG, GIF, TIF and PNG formats.

Desktop Icons

With Windows Vista®, the following icons* are installed on your Desktop:

Recycle Bin – Gives you a container in which to put and discard unwanted files or allows you to restore these same files back to their original location.

Taskbar Icons

With Windows Vista®, a number of icons appear on the taskbar. Use the cursor to hover over an icon and display its function. Right-click on the icon to display its menu options, or double-click on the icon to launch it.

Right click an empty area of the taskbar and select **Properties** to recognise the taskbar.

For more information, please refer to: **Windows Vista® Operating System Introduction** → **Tips for Using Windows Vista®** in this Electronic User's Guide.

Page
33

The quick launch on the left hand side of the taskbar can be hidden or active. The notification area on the right hand side of the taskbar can be easily configured, for instance, to hide icons that are not used frequently. Some hardware items or software titles will place a small icon in this area, allowing you to easily recognise and control their settings or status (examples are virus scanners, printers, PC cards).



The following icons* normally appear in the notification area:

Time Clock – Allows you to adjust the time and date, select your time zone, and offers the option to automatically synchronise the time with an Internet time server.

For more information about the Desktop and taskbar icons, refer to the Windows Vista® online help. To do this, click on **Start** button , and select **Help and Support**.

Depending on the version of Windows Vista® installed on your notebook or if you have deactivated certain programs, the icons described here may differ slightly and/or may be accompanied by others.

Start Menu

The **Start** menu features a whole new look and feel. The Windows® Internet Explorer icon has a prominent place now. You will also notice that Windows Vista® places your frequently used programs in the white area of the Start menu. It is safe to remove an item from this list by right-clicking the icon and selecting **Remove from this list**, as the software program itself will not be deleted.

You can access your installed software and other Windows® programs by selecting **All Programs**. Recently installed programs are highlighted.

Technical Support Information

Technical support information is available in Windows Vista®.

Click the **Start** button , right-click on **Computer** and select **Properties**.

Managing System Power (Windows Vista® Operating System)

In the Windows Vista® operating system environment, your notebook manages its power resources using the Advanced Configuration and Power Interface (ACPI) while the notebook is powered on using AC or battery (DC) power. ACPI enables the operating system to manage the power given to each attached device and to turn off a device when not in use.

Take advantage of the opportunity to manage power on your notebook to:

- Minimise battery drain.
- Preserve the life of your notebook.
- Save time. When you return from that urgent call or meeting, you don't have to reboot, just press the Power button to resume notebook operation.

Windows Vista® Operating System Power Options Properties

In Windows Vista® operating system, most ACPI power management settings are controlled through Windows® Power Options, not through the BIOS Setup utility, unless otherwise noted.

To access Windows® Power Options, click the **Start** button , **Control Panel**, select **Performance and Maintenance**, double click **Power Options**.

The Power Options Properties are broken down as follows:

Power Plan

Use the **Power Schemes** tab options to define the appropriate power scheme for your notebook, and to set timeouts for standby, monitor, and hard disk.

Parameter	Options	Description
Power Plan	VERSA Balanced Power Saver High Performance	Defines the most appropriate power scheme for your notebook.
Turn off monitor (plugged in)	½/3/5/ 10 /15/25/30/45 minutes ½/3/4/5 hours Never	Selects the time delay before your LCD panel turns off.
Turn off monitor (running on batteries)	½/3/10/15/20/25/30/45 minutes ½/3/4/5 hours Never	Selects the time delay before your LCD panel turns off.
Turn off hard disks (plugged in)	3/5/10/15/20/25/30/45 minutes ½/3/4/5 hours Never	Selects the time delay before your hard disk(s) power down.
Turn off hard disks (running on batteries)	3 /5/10/15/20/25/30/45 minutes ½/3/4/5 hours Never	Selects the time delay before your hard disk(s) power down.
System Sleep (plugged in)	½/3/5/10/15/ 20 /25/30/45 minutes 2/3/4/5 hours Never	Selects the system sleep timeout period for your notebook when running under AC power.

System Sleep (running on batteries)	½/3/5/10//20/25/30/45 minutes ½/3/4/5 hours Never	Selects the system sleep timeout period for your notebook when running under DC power.
System Hibernates (plugged in)	Never	Selects the system hibernation timeout period for your notebook when running under AC power.
System Hibernates (running on batteries)	Never	Selects the system hibernation timeout period for your notebook when running under DC power.

Default settings are shown in red.

Alarms

Use the **Alarms** tab to define the point at which the battery alarm activates. Define the alarm to either sound, display a warning message, or invoke Standby, Hibernate or Shutdown.

Parameter	Options	Description
Low battery alarm	10% 0-100%	Allows you to define a low battery alarm percentage, notification, and system action.
Notification	Display message Sound alarm	Allows you to define whether the alarm is visual or auditive.
Alarm Action	Sleep Hibernate Shut down Do nothing	Allows you to define which action is taken by the notebook when the alarm goes off.
Critical battery alarm	3% 0-100%	Allows you to define a critical battery alarm percentage, notification, and system action.
Notification	Display message Sound alarm	Allows you to define whether the alarm is visual or auditive.
Alarm Action	Sleep Hibernate Shut down	Allows you to define which action is taken by the notebook when the alarm goes off.

Default settings are shown in red.

Advanced

The **Advanced** tab allows you to select the power-saving settings you want to use.

Parameter	Options	Description
Always show icon on taskbar	Checked Unchecked	Determines whether or not the Power Meter icon displays on the taskbar.

Prompt for password when notebook resumes from standby	Checked Unchecked	Determines whether or not the notebook prompts for your Windows® password when resuming from Standby.
When I close the lid on my notebook	Standby Do nothing Hibernate	Defines the system action when the LCD panel is closed.
When I press the Power button on my notebook	Shut down Standby Hibernate Do nothing Ask me what to do	Defines the system action when the Power button is used.

Default settings are shown in red.

Tips for Using Windows Vista®

For more information, we advise you to check out the new features specific to Windows Vista®.

To do so, click the **Start** button , click on **Help and Support**, and pick the **What's new?** Topic.

Frequently Asked Questions (FAQ) Windows Vista®

We continually strive to bring you the latest and proven features and technologies. As part of our drive to continually improve our products, software incompatible issues might occur on brand new operating system. We are working with our partners to address these issues and deliver solutions to you as soon as possible.

Please visit our "Questions and Answers" website frequently to obtain the latest information and updates regarding your notebook:

<http://www.nec-computers-ap.com/faq/vista.asp>

Lastly, when you run MDVD Creator program, a section might be hidden depending on the screen resolution. In this case, please resize the window by dragging the sides.

Notebook Components

For details of notebook components, please refer to the System Configuration label.

System Configuration Label

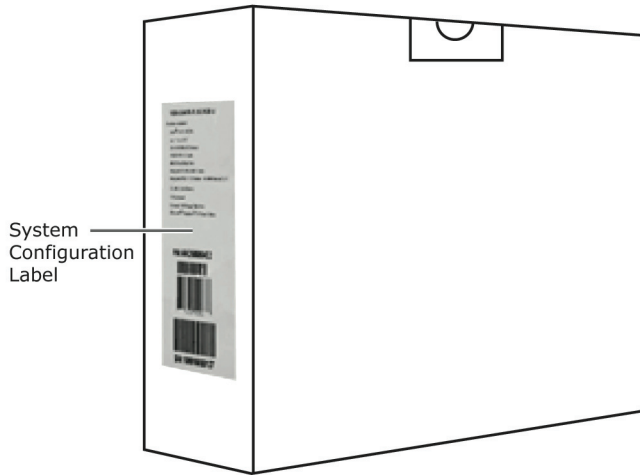

Applications

Adobe® Reader®

Adobe® Reader® allows you to view, navigate, and print Portable Document Format (PDF) files from your local hard drive, your local network, or the Internet.

Plug-Ins

Several plug-ins may have been installed on your notebook to enhance your internet experience.

What is a plug-in ?

A plug-in is a component that allows you, for example, to read specific file formats, listen to sounds or watch movies over the internet by extending your browser capabilities.

Adobe® Reader® Plug-In

The Adobe® Reader® plug-in lets you visualise PDF files within your browser. This format is used to view, navigate and print files right in your browser. PDF files are extremely compact, platform-independent, offer design control and are ready to print.

Adobe® ShockWave® Plug-In

Adobe® ShockWave® is one of the industry standards for downloading and experiencing interactive multimedia, graphics and audio on the web.

This plug-in allows you to experience high resolution images and graphics, zooming and panning up to 25000 % without losing any of the original picture quality. The plug in also lets you experience exciting interactive animations that can include audio from hi-fi to CD quality.

Adobe® Flash® Plug-In

Adobe® Flash® is another plug-in that lets you experience vector based animation over the web. Flash files are very small, animated graphics and drawings that play on web pages in real time, even over a slow connection. Flash also gives you interactive buttons, anti-aliased graphics, outline fonts and zooming control for use on web pages.

DirectX Plug-In

DirectX is a Windows® technology that enables higher performance in graphics and sound when you're playing games or watching video on your notebook.

The software varies according to the model and is subject to change without notice (for specific models only).

Bluetooth® Wireless Technology

Bluetooth® wireless technology eliminates the need for connecting cables between your computer and your local area network, facilitating mobility, minimising downtime and improving your productivity. Please refer to the following steps to launch the Bluetooth® wireless technology software.

Click **Start** , go to **All Programs**, select **Application Setup** and then click **Bluetooth**.

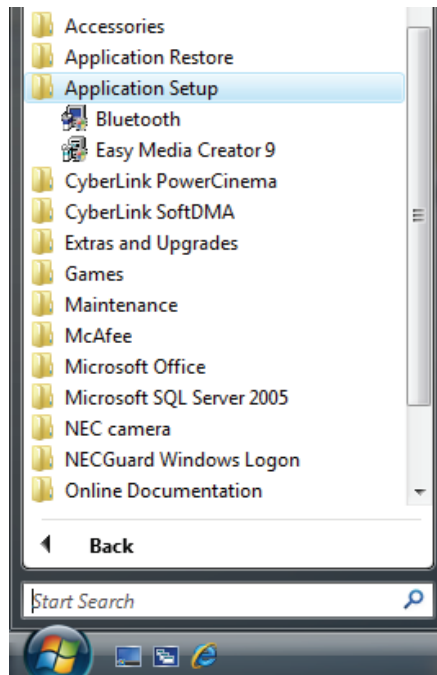



The software varies according to the model and is subject to change without notice (for specific models only).

Blu-ray

Blu-ray (BR) discs are an advanced type of optical disc that has a very high storage capacity (a dual-layer BR disc can store 50 GB of data), and is typically used to store high definition (HD) content such as HD movies.

The CyberLink PowerDVD software has been preinstalled and can be used to play Blu-ray Disc titles (BR-DVD).

Click the **Start** button , click **All Programs**, then click **PowerDVD**  to launch the PowerDVD program. Configure PowerDVD according to regional settings prior to playback of BR-DVD.

PowerDVD might display the message: "A critical component of the player requires periodic updates".

Click "Yes" to connect to the CyberLink website and download the updated version of PowerDVD for automatic AACSS (Advanced Access Content System) keys renewal.

This online update is important for successful playback of Blu-ray titles with AACSS protection.

1. To play the BR-DVD based on country region, please check the back of the BR-DVD movie cover for corresponding regions code. There are 4 types of region codes: A, B, C and All Regions.



2. Launch the DVD program, then click on the settings-icon on the main screen as shown below:



3. Change the region settings to the movie region accordingly on the region code tab and click on "OK" to apply settings.



4. You are now ready to playback the BR-DVD movie.



Note

The Blu-ray Disc titles can only be playback using the PowerDVD program. The region setting allows you to set to a maximum of 5 changes. All regions BR-DVDs do not require any region setting change.

The software varies according to the model and is subject to change without notice (for specific models only).

CyberLink MakeDisc 3

Easy DVD Burning for the Digital Home

- Burn videos and photo slideshows to CDs, DVDs as well as Blu-Ray discs.
- Import recorded TV Shows and burn to CDs, DVDs as well as Blu-Ray discs.
- Select a themed menu for easy DVD navigation.
- Backup data files onto CDs and DVDs.
- Create music CDs from MP3 or WMA files.

Create DVDs from your Favourite Videos and Photos



MakeDisc enhances Windows® Media Center with these features:

- Authoring and burning videos to CDs, DVDs as well as Blu-Ray discs.
- Authoring and burning photo slideshows to CDs, DVDs as well as Blu-Ray discs.
- Adding a disc menu from a range of built-in templates.
- Burning music to Audio CD, or as an MP3/WMA disc.
- Burning data to CDs and DVDs.

Import All Kinds of File Formats – Including Record TV

- **Auto detection of TV aspect ratios** ensures that recorded TV programs are output and authored in the same menu size as the captured content. MakeDisc intelligently detects the aspect ratio of the majority of the captured digital TV content, not just the first frame like other software.
- MakeDisc is compatible with the most popular data, video, photo and music formats which makes for easy creation of data CDs and DVDs, music CDs, video DVDs, mixed photo/video CDs and DVDs.

Create Stylish DVD Menus



- Choose from thematic menu styles for your photo slideshow and video DVDs.
- Add background music by choosing MP3, WAV and WMA formats from your hard drive.

Burn to CDs, DVDs and Blu-Ray Discs

- MakeDisc supports a broad range of disc types and burners, including CD-R/+R, CD-RW/+RW, DVD-R/+R, DVD-RW/+RW, double layer discs/drives and Blu-Ray discs.
- Automatically fit your video/slideshow onto your available DVD space with Smart Fit.

The software varies according to the model and is subject to change without notice (for specific models only).

CyberLink SoftDMA 1.5

The CyberLink Media Server application allows you to share your media files with your family members within your home network. CyberLink Media Server shares all of your media files across the network with any computers that has CyberLink SoftDMA installed.

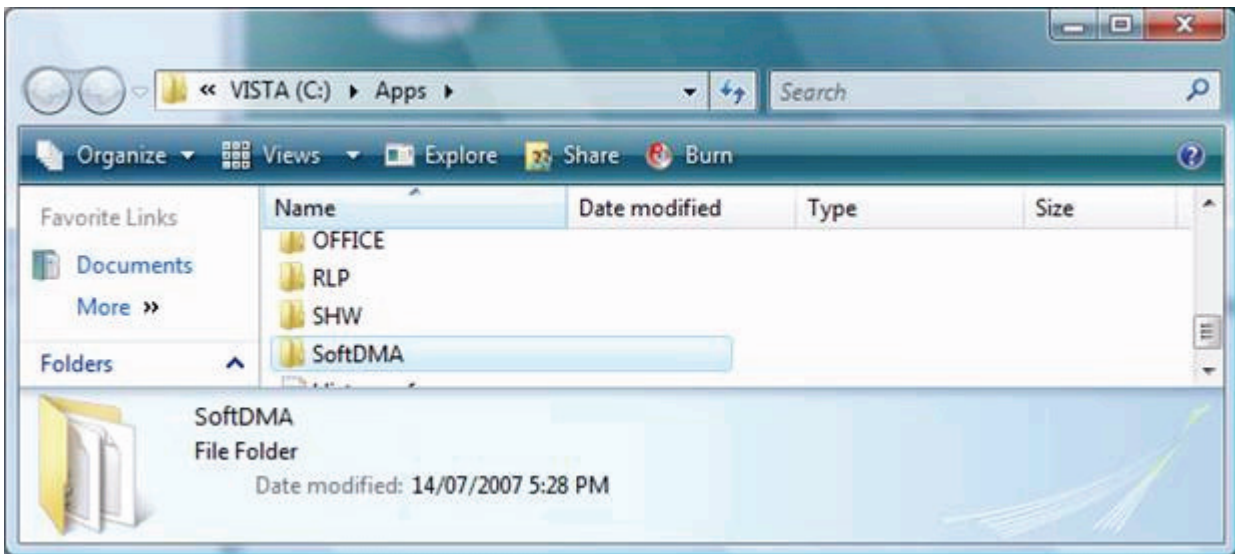

To enhance your complete digital home experience, you have 1 licensed copy of CyberLink SoftDMA that can be installed onto any of your other existing computers.

SoftDMA installation files are located in the folder: **c:\Apps\SoftDMA**.

You first need to transfer all the files in the SoftDMA folder to a removable media such as a USB flash drive or rewritable CD. On the targeted computer, run the **SETUP.EXE** file to install SoftDMA.

The setup process will require an installation key and it can be obtained upon completion of your warranty registration. Kindly register your NEC Computer at <http://www.nec-computers-ap.com/regwarranty> or you may contact your local call centre for further assistance.

Thank you for choosing an NEC computer. We hope that your experience with this new system will be pleasurable.

The software varies according to the model and is subject to change without notice (for specific models only).

McAfee® Internet Security Suite with Site Advisor™

Features 10-in-1 always updating security that proactively guards your computer and what you value, blocks offensive content and prevents malicious activity.



10-in1 Protection

- Safe Search and Surf
- Home License Subscription
- Stop Viruses
- Halts Hackers
- Blocks Spyware
- Improves Computer Health
- Secures Your Identity
- Prevents Spam and Email Scams
- Protects Children Online
- Backs Up and Restores Files



Safe Search and Surf

McAfee® Internet Security Suite with SiteAdvisor™ adds safety ratings to websites and search engine results based on comprehensive spam, adware, and online scam safety tests. SiteAdvisor™ analyses the results and rates websites in detail for unsafe or annoying practices such as dangerous downloads, spamming, misuse of personal information and browser hijacking. When searching with Google, Yahoo! or MSN, SiteAdvisor™ provides easy-to-understand safety ratings—red (danger), yellow (use caution) or green (safe)—that appear next to search results, helping you make informed decisions. PC World Magazine named McAfee® SiteAdvisor™ 15th on their list of the top 100 products of 2007.

Home License Subscription Service

McAfee® Internet Security Suite with SiteAdvisor secures up to 3 personal computers and automatically delivers the latest software features and threat updates. The suite allows you to easily manage security subscriptions for each computer that you are protecting under your McAfee® subscription.

Stops Viruses

McAfee® Internet Security Suite with SiteAdvisor™ automatically guards your computer, email, instant messenger, downloads, photos, music files, videos, financial records, online banking and shopping, and privacy from viruses, mass-mailing worms, backdoor Trojans and more. It also automatically cleans or quarantines infections with minimal interruption to your computing. McAfee®'s world-renowned Avert Labs researchers provide daily updates that deliver fast, immediate protection from the latest threats. Other built-in features include: McAfee® SystemGuards watch for activity that may signal a virus, spyware or hacker is on your PC. Always active detection that watches key system, Windows®, host file and browser settings for suspicious changes such as DNS poisoning (or pharming, which can redirect surfing to fraudulent websites) or activity that can compromise anti-virus security (such as buffer overflow attacks). McAfee® X-Ray for Windows® removes dangerous root-kits and other malware that can hide deep in your operating system.

Halts Hackers

Constant inbound and outbound monitoring helps McAfee® deter hackers, identity thieves and malware programs from robbing data, hijacking your system (such as to send spam) or planting viruses that can compromise privacy over dial-up or broadband. Fast "load and go" setup, customizable security levels, visual tracing, smart alerts, full screen mode and intelligent application handling help fine tune security, identify the source of threats and block suspect programs from "phoning home" personal information. Other built-in features include: Stealth Mode helps hide your presence online, making your system practically invisible to global hackers. HotSpot detection automatically elevates McAfee® firewall security when you are not on your trusted network. Boot-time protection shields your system from unauthorised connections before security programs are fully loaded.

Blocks Spyware

McAfee®'s spyware protection detects, blocks, and removes spyware, adware, and other suspicious programs before they can steal log-ins and passwords (key-loggers), hijack your dial-up connection (Web dialers), track online surfing (cookies) or flood your surfing with annoying pop-up ads. Better protection based on new integrated anti-virus, anti-spyware engine. Now also detects and blocks tracking cookies.

Improves Computer Health

McAfee® SecurityCenter's dashboard-like display helps you at a glance review your PC's security status and modify it with one-click. You can also easily check for updates, fix potential security issues or view settings in basic or advanced modes. With built-in McAfee® QuickClean technology, McAfee® Internet Security Suite with SiteAdvisor™ helps optimize your PC's performance, eliminating drive-clogging "Internet build-up" (e.g., temp files, cached files, file remnants, Active X code), unused programs and other unnecessary clutter to free up valuable disk space. It also features a network map that shows the security status of your home network.

Secures Your Identity

McAfee® Internet Security Suite with SiteAdvisor™ helps secure personal identification and financial information (such as name, phone, credit card, bank account numbers) from transmission over the Internet without permission. Featuring McAfee® Shredder, sensitive files can be permanently deleted so as not to compromise your privacy. McAfee®'s anti-virus, anti-spyware, firewall and anti-spam security work together as a multi-layered shield against multi-faceted identity theft threats that may use a combination of malware to steal files, financial log-ins and other personally identifiable information. The suite also includes Password Vault, which safely stores Web login-ins, passwords and other personally identifiable information in a secure, password-protected, easy-to-access location.

Prevents Spam and Email Scam

McAfee® Internet Security Suite with SiteAdvisor™ automatically recognizes and helps stop junk email—including identity and credit card scams, virus hoaxes and foreign language spam—from polluting your inboxes while letting trusted email through. Timely anti-spam filter updates ensure that you have the latest protection against spammers. More accurate spam detection, filtering and blocking with fewer false positives (email accidentally labeled spam).

Protects Children Online

McAfee® Internet Security Suite with SiteAdvisor™ helps shield each family member from inappropriate Web content, online predators and chat using age-specific adjustable settings and easy-to-use filtering options. Also, the suite features McAfee® ImageAnalyzer that protects children from viewing offensive images online.

Backs Up and Restores Files

McAfee® Internet Security Suite with SiteAdvisor™ provides an automated back-up feature that preserves encrypted copies of irreplaceable photos, music files, videos and documents on CD/DVD, USB or external or network drives. With one-click, you can easily retrieve these archived files.

The software varies according to the model and is subject to change without notice (for specific models only).

Roxio Creator LJ

- Burn Data, Audio, Photo and Video CDs & DVDs.
- Backup fast and copy with ease
- Rips CDs Music to Local HDD
- Disc's Image Creation & Burning

Get the most out of your digital videos, music and photos. Roxio Creator LJ lets you create, manage and enjoy them the way you want them - where you want them.

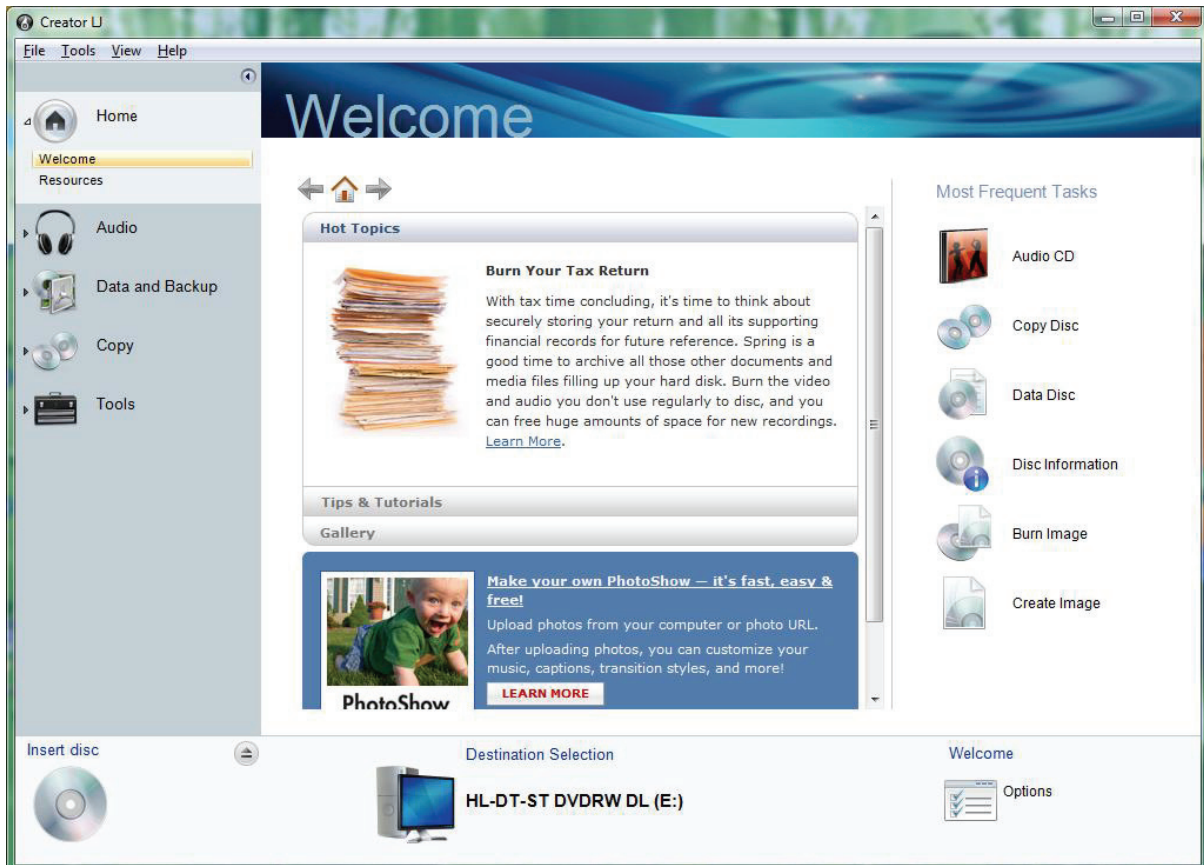

Music

- Copy Audio CDs or create your own music mix from several CDs
- Automatically burn hundreds songs across multiple CDs
- Easily rip Audio CDs into WAV, WMA, OGG & FLAC
- Create Jukebox CDs (MP3, WMA, WAV CDs)
- Make custom Audio CDs for your car or home CD Player

Data

- Create mastered data discs.
- Make exact copies of data discs.
- Erase re-writable discs.
- Create bootable discs to recover your system in case of a crash.

Back Up

- Easy Archive back up to CDs, DVDs, external or network drives.
- Make exact copies of discs.
- Create and burn images of CDs and DVDs.

More Features

- Integrated disc labeling for professional results.
- Intelligent drag and drop takes the hassle out of burning.
- Easy-to-use task based interface.
- Tutorial to help you get started.
- Support and product updates.
- Roxio Media Center leads you to the latest update of Roxio's new products, techniques and tips.

Advanced Options

- Normalisation and Noise reduction for audio CDs.
- Ability to control burn speeds.
- Control write format including ISO, ISO level 2, Joilet and UDF.
- Record types – Disc-at-once, Track-at-once, open or closed.
- Pre-mastering cache, file date and time.
- Switch between mini mode and full mode interface.

The software varies according to the model and is subject to change without notice (for specific models only).

SRS Premium Sound

SRS Premium Sound from SRS Labs is an audio enhancement technology to enable your computer with higher quality audio. In order to activate SRS Premium Sound, please double click on its icon on the Windows® desktop.



Once activated, it will be automatically loaded every time you start your computer.

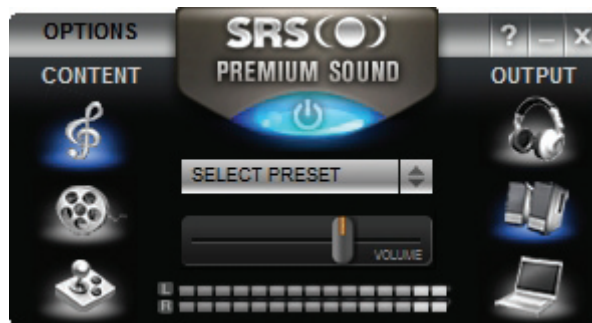

For further information, please refer to its on-screen help.

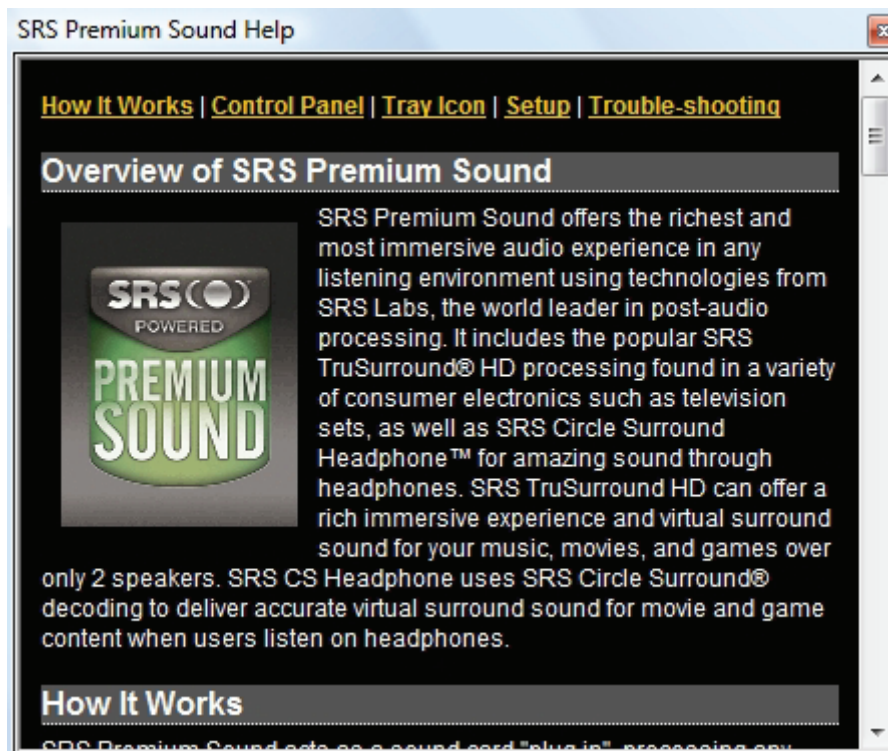

The software varies according to the model and is subject to change without notice (for specific models only).

Using your NEC VERSA

Removable Disk Drives

Optical Drive

An optical drive is a type of drive that uses laser light to read from and store data on optical discs. Optical discs are commonly used to read, store, transfer or share data, especially for media-rich content. Typically, your optical drive should be able to access most common optical discs such as CDs and DVDs. The optical drive that comes with your notebook depends on the notebook configurations you purchase.

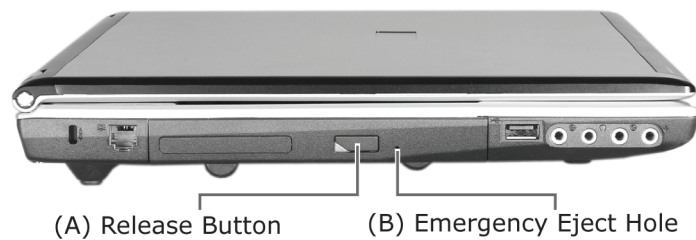

- **Release Button (A)** - ejects the disc tray. Press this button when power is on to insert a CD into or remove a CD from the drive.
- **Emergency Eject Hole (B)** - allows you to manually remove a disc from the CD-ROM drive if the eject function is disabled by software or a power failure occurs. To remove a disc, insert the end of a paper clip into the eject hole, and push in until you hear a click. Manually open the drawer.

General Information about Optical Discs

Disc Loading

To insert a disc into the optical disc drive, follow these steps.

1. Press the Release button. The disc tray emerges a short way out of the drive door.
2. Gently pull the tray out until you can easily position a disc in the tray.
3. Put the disc, printed side up, into the circular impression in the tray.
4. Push the disc tray in until it clicks shut.



Note

Some discs vibrate when playing. This does not affect the optical disc drive.

Disc Care

When handling optical discs, keep the following guidelines in mind.

- Hold optical discs by the outer edge and the inner hub to avoid damaging the surface. Avoid direct contact with the disc's surface.
- Avoid scratching or soiling both sides of the disc.
- Do not write on or apply labels to either side of the disc. Never write with a ballpoint on the surface of the disc.
- Do not use stickers, labels or write on both sides of a disc. Unless you use specific label kits, never use a tape or sticky material to label optical discs. Since the data layer of a disk is right beneath the printed label, writing with a pen can scratch the thin reflective aluminium coating. Use soft-tip pens especially for re-writable disks that are even more sensitive.
- Do not scratch or polish the label side. The pits and lands (microscopic holes and flat areas) that encode the information in the CD are on the label side, and not on the surface read by the lens. Large scratches on the underside, however, can often be repaired using special polishing kits. Most of the time, the laser, which focuses on a layer within the clear base, is able to see past small scratches, in much the same way the human eye can focus on objects outside when looking through a window.
- Keep the disc away from direct sunlight, high temperatures, and humidity.
- Keep optical discs away from high temperatures. Don't subject disks at temperature levels exceeding 37°C. Exposure to direct sunlight over long periods easily warps a disk. Low temperatures are not a hazard, but wait for a stable temperature before loading a disk. Disks burned using CD-writer drives are more sensitive and should be stored at room temperature whenever possible.
- Moisture does not affect other types of discs, but avoid exposing re-writable disks to liquids. In case of accidental spills on discs, rinse it off with lukewarm water and wipe dry with a soft cloth. Be careful with sticky or oily substances that trap dirt and dust.
- Proper cleaning is important to achieve optimal performance. Using a soft, slightly damp cloth, wipe the disc from inside the disk and rub outwards. Do not wipe in circles but clean in the same outward direction. Wiping the label side in circles can scratch a section of the data track. Slightly dipping the cloth in warm water is enough. Using cleaners and solvents can do damage.



CAUTION

Since discs are coated with thin layers of aluminium and plastic, avoid using benzene, paint thinner, record cleaner, static repellent, or any other chemical to clean the disc. Chemicals and cleaners can damage the disc.

Optical Disc Drive Care

To get the most from your optical disc drive, keep the following guidelines in mind.

- Never forcibly pry open a drive whenever a disc gets stuck. The plastic tray is a relatively fragile and vulnerable mechanism. Loading a CD off-centre is a common mistake that can jam the tray. If this happens use the eject button, or the emergency eject hole. If that fails, ask for professional help.
- Avoid excessive dirt and dust build-up on optical discs. Optical discs can tolerate accumulated dirt and dust much better than floppy disks since CDs are not read by direct contact with the read lens. Excessive dirt, however, will eventually affect the drive's performance. Thoroughly clean the discs whenever necessary.

Bays

Hard Disk Drive

A hard disk drive (HDD) is a non-volatile storage device which stores digitally encoded data on rapidly rotating platters with magnetic surfaces. On most systems, it is a sealed unit (except for a filtered vent hole to equalize air pressure) with fixed media. The HDD is your notebook's primary storage device, storing all of your system files and installed programs. Therefore, it is also usually your notebook's largest storage device (in today's systems, it is quite common for a single consumer HDD to have capacities of over 100 GB, and desktops tend to have larger capacities than notebooks).

Depending on your system configuration, the HDD may be upgraded to a larger capacity drive. Some systems may even have more than one HDD installed.



Note

Please contact your authorised service representative if you wish to replace your hard disk drive. This procedure should only be performed by a qualified technician.

Taking Care of Your Notebook

Notebook Care

Observe the following measures to prevent problems and promote the successful operation and long life-span of your notebook.

Protecting Your Notebook From Power Outages

Fortunately, there are tools that can help when power supply is interrupted. Basically there are two types of protection against power problems, a passive form such as those provided by surge suppressors and a multi-featured back-up power source like the UPS.

- **Surge Suppressors** - although computers are equipped with some surge protection, it is wise to acquire a separate surge suppressor for added protection. A surge suppressor protects power supplies and communication lines from electrical surges but does not offer a back-up power source. While some suppressors have a manual on-off switch, other types combine switched and unswitched circuits. A mix of switched and unswitched circuits can be a useful feature since you can keep, for instance, a battery charging while shutting off the power for other equipment.
- **Back-UPS units** - equipped with a battery to maintain power during outages, the UPS allows users to save data and properly shut down the notebook. Most UPS also include surge protection as a feature. There are two basic UPS types, the standby power supply (the least expensive choice) and the multi-featured on-line UPS systems.

Below are tips on power protection and some hardware features to consider before buying these devices:

- Be sure to unplug your notebook, including the line to the modem, during lightning storms.
- Always use a proper power cord to plug your notebook to the line power. When using an extension cord make sure it is a reliable cord.
- Look into the energy absorption features. Surge suppressors are rated by the amount of energy they can absorb, which is measured in joules. The higher the surge ratings the better the unit. Experts say around 200 joules is basic protection, 400 joules provide good protection and 600 joules or more is far better.
- Check if a surge suppressor has a circuit breaker or fuse. Many suppressors are equipped with either a circuit breaker or fuse that will blow or trip in case of a short circuit and severe surges. Compared to fuses, circuit breakers are preferred because fuses have to be replaced when damaged by a short circuit.

Protecting Your Notebook From Damage

There are several ways in which you can protect your notebook from possible damage. We strongly recommend the following protective measures:

- Connect a Back-UPS unit (see "*Protecting Your Notebook From Power Outages*" above) between your notebook and the grounded AC power outlet. A Back-UPS unit protects your notebook from sudden transient increases and decreases in electrical power.
- Be sure to connect all peripherals, such as your monitor and printer, to the Back-UPS unit that should be the only device that you plug into the AC power outlet.
- Avoid repeated power-on cycles. These subject the notebook components to temperature variations and stress.

- Disconnect your notebook from telephone, LAN and power lines when an electrical storm threatens. If you have a fax/modem, lightning can travel in on the phone line and can damage both the fax/modem and the system unit. Lightning can also travel in on power lines and damage your monitor and system unit.



Note

Please note that the product warranty does not apply if damage to your notebook is the result of a lightning strike.

- Be sure that notebook power is off before you connect or disconnect a cable (except USB and IEEE 1394 devices, that can be hot-swapped and hot-plugged). Never make cable changes when the notebook power is on. Doing so could damage your notebook and its peripherals.
- Use appropriate virus detection software regularly to protect your notebook from computer viruses.
- Place your notebook away from direct sunlight and extreme temperatures. Operate and store your notebook within the recommended temperatures and humidity levels.

For more information, please refer to: **Safety Notices** → **Product Storage Environment Guidelines** in this Electronic User's Guide.

**Page
88**

- After turning off power, wait about five seconds for the hard disk to spin down before you power on again.
- Be sure that nothing is placed on top of your AC adaptor and notebook power cables.
- Prevent dust from entering your notebook by covering it when it is not in use.

Keeping Your Notebook in Good Condition

Maintain the condition of your notebook by periodically using the following general procedures.



WARNING

For safety, power off and unplug your notebook, monitor and any external devices before cleaning them.

- Clean the outside of the notebook with a soft clean cloth. You can remove stubborn stains with a cloth slightly dampened with a mild detergent. Never use a strong cleaner or solvent on any part of the notebook.
- Keep food and liquids away from your notebook.
- Periodically clean the keyboard with a vacuum cleaner brush attachment. Do not use any liquid cleaners on the keyboard as they can damage it.
- Clean the monitor screen with a monitor glass cleaner and wipe it with a clean, lint-free cloth.
- If you connect an external mouse to your notebook, periodically clean the mouse as explained below (this procedure does not apply to optical mice):
 - Power off your notebook and any peripherals attached to it.
 - Invert the mouse. Locate the mouse ball cover
 - Rotate the ball cover counter-clockwise and remove the cover.
 - Turn the mouse over so that the cover and ball fall into your palm.
 - Clean the mouse as follows; first use tap water, or tap water and a mild detergent, to clean the mouse ball. Use a clean, lint-free cloth to dry the ball, and blow into the mouse socket to remove remaining dust or lint.
 - Gently put the ball back into the mouse.
 - Fit the ball cover back into the mouse and turn the cover clockwise until it locks in place.

Security

- **Basic Input/Output System (BIOS)** - refer to the relevant **BIOS chapter** for more information on how to set Supervisor and User passwords.
- **Operating System** - Set user accounts and passwords.

For more information, please refer to: **Windows Vista® Operating System Introduction** → **Tips for Using Windows Vista®** in this Electronic User's Guide.

Page
33

- **Hardware** - Your notebook may feature a Security Cable slot. This lock may prevent your notebook from being moved or stolen.

Install an optional Security Cable as follows:

1. Select the object in the room to which you will secure your notebook. Choose an immovable piece of furniture or fixture (a table or desk leg with a cross bar).
2. Take the looped end of the steel cable (For specific models only) and wrap around the immovable object. Be sure to choose an object that prevents an intruder from slipping the cable out from under the object.
3. Feed the locking device through the looped end of the cable.
4. To install the Security Cable, make sure that the lock is in the unlocked position. To do so, insert the key into the lock and, holding the locking device stable, turn the key clockwise to the unlocked position.
5. Insert the locking device into the Security Cable slot in your notebook. Turn the key 90° counter-clockwise to lock and remove the key. Check that the Security Cable is secure by gently pulling on the locking device.

Operating Environment

Caring for your notebook also requires taking into account the effect of temperature, humidity, and moisture on notebook components. Like any other electronic products, notebooks are vulnerable to drastic changes in temperature, and especially moisture on notebook components.

Please follow the tips below regarding the recommended operating environment:

- **Avoid using your notebook in high humidity** - computers are best used in moderate humidity conditions. Although notebooks are more sensitive to temperature than to humidity, using a notebook in a humid environment can present problems especially when the humidity reaches extreme levels. A few humid days is not really a cause for concern but using, for instance, a laptop in a tropical jungle can present wear-out issues. Humidity hastens corrosion and increases the risk of condensation that can damage certain parts. Going directly from a cold to a warm environment leads to condensation. Cooling a notebook is also difficult when humidity is high.
- **Before switching on, allow the notebook to adjust to room temperature** - in general, electronic equipments that have been exposed or stored in very low temperatures should adjust gradually to room temperature before they are switched on. Immediately powering on a notebook that has been stored for some time at low temperatures in an environment with high temperatures increases the risk of damaging parts.
- **Do not expose the notebook to moisture and spills** - users tend to stretch the limits by using and leaving their notebooks at the most unlikely places like the kitchen, the bathroom, on the garden table or by the swimming pool where the chance of it getting wet is high. Placing a notebook near an open window is also not advisable since it can easily collect and expose some parts to moisture. Be wary of liquid spilling into the power supply since it may trigger an electric short-circuit.
- **Keep your notebook cool** - the key components in your notebook that require special attention when it comes to cooling and proper ventilation are the power supply, the CPU, the hard drive and the motherboard.
 - The fan in the power supply is designed not only to provide better airflow to the entire case, but also to cool parts of the power supply that easily heat up.
 - CPUs are equipped with sophisticated heat sinks and fans to increase reliability and prevent cooling-related problems like system lockups.
 - Fans do not directly cool the hard drive and components of the motherboard, but provide better airflow to these parts. Cleaning the box and removing dust are beneficial since accumulated dust can insulate the notebook making it difficult to cool the notebook.
- **Ensure effective ventilation for your notebook** - even with sophisticated power supply and CPU fans it is still important to install your notebook where there is good ventilation to avoid overheating. Airflow, obviously, is more important in a warm room than in a cool area. Pay attention to the obvious, such as providing space for the power supply fan to blow freely and by not blocking the air vents that keep your notebook, monitor and other devices from overheating. Good operating temperatures would be from 5°C to 35°C, and cooler temperatures are generally better than higher temperatures.

Preventive Maintenance

The following information will help you to set up a preventive maintenance plan in order to prevent notebook problems. Depending on what your notebook is being used for, adapt them to your own needs.

These suggestions are classified according to the recommended frequency.

First Time Use

Back up your BIOS settings: these parameters saved in the CMOS memory define how your notebook works and minor changes to them can modify the way your notebook functions. To back up the BIOS settings, take a piece of paper, **enter the BIOS** and note the settings and their values.

For more information, please refer to: **Introducing BIOS Setup for Windows Vista®** in this Electronic User's Guide.

Page
26



Note

Do not forget to modify what is written on this piece of paper each time you modify the BIOS settings.

Daily



Note

The suggestions below are only relevant to Microsoft® operating systems.

Scan for viruses: your notebook is delivered with an **antivirus software** pre-installed on your hard drive. For better security we recommend you use the automatic scanning option and perform on-demand scanning.



CAUTION

Update the virus definition files at least once every month, or as soon as you hear about a new virus.

Back up your data on a regular basis: you can use the *Microsoft® Backup* tool to save your files from your notebook to media such as a floppy diskette, a CD or a removable hard disk. Refer to the Windows® online help for more information.

Weekly



Note

The suggestions below are only relevant to Microsoft® operating systems.

Scan for hard disk logical and physical errors: to do so, use *Microsoft® ScanDisk*, also known as the *Error-checking* tool (depending on the operating system). Refer to the Windows® online help for more information.

Clean up your hard drive by using the *Disk Cleanup* option in Windows®.

Defragment your hard drive: it will allow your notebook to run at peak performance. You can use *Microsoft® Disk Defragmenter* to perform this process. Refer to the Windows® online help for more information.

Shipping Your Notebook

Use these steps to prepare your notebook for shipping:

1. Back up the files on the hard disk drive to diskettes, Zip disks, CDs or DVDs.



Note

Be sure to take precautions for storing and transporting Zip disks, floppy disks, CDs or DVDs so that they are not exposed to magnetic fields or electrical impulses.

2. Remove any media from its respective drive.
3. Turn off the notebook and any external options connected to it.
4. Unplug the AC adaptor from the AC power outlet or Back-UPS unit, then from the notebook itself.
5. Pack the notebook components in the original shipping materials and cartons. If these are not available, be sure to use adequate packing materials to protect the components.

Modem

The modem allows you to communicate with others via e-mail, or connect to an online service or bulletin board. (The modem port is only available on some models.)

The speed of data transmission is dependent on the quality of telephone lines. Digitally terminated lines improve the speed of data transmission. Contact your service provider for more information.



Note

In some instances, your modem may not detect the correct country as your default country settings. In this case, you will need to change the country settings manually.

Connecting using a Modem

The modem provides one standard phone connector.



Note

When using a modem outside of the country where you purchased it, you might need an international telephone adaptor, available at most electronic supply shops.

Use the following steps to connect the analogue phone cable to your modem.

1. Locate the analogue phone cable that comes with the notebook. Each end of the cable is fitted with a RJ-11 connector.
2. Connect one end of the cable into a standard telephone wall outlet, using the adaptor if necessary.
3. Connect the other end of the cable into the modem port on your notebook.

Local Area Network (LAN)

The internal LAN feature allows you to connect your notebook to a local area network. The internal LAN feature allows a 10/100 Ethernet LAN connection and supports Wake-on-LAN and network boot functions.

Follow these steps to take advantage of the internal LAN feature.

1. Locate the LAN port on the notebook.
2. Plug one end of your LAN cable into the LAN port.
3. Plug the other end of the LAN cable to a local area network.

Bluetooth® Wireless Technology / Wireless LAN

The *Bluetooth*® Wireless Technology and Wireless LAN feature allows you to connect your computer to a wireless network using a wireless connection.

Follow these steps to take advantage of the *Bluetooth*® Wireless Technology or Wireless LAN feature.

1. Locate the Wireless LAN or *Bluetooth*® Wireless Technology multimedia sensor on the notebook.
2. Tap the corresponding multimedia sensor once to turn On either the *Bluetooth*® Wireless Technology or Wireless LAN. The notebook will automatically detect and attempt to connect to a wireless network.
3. Press the corresponding sensor once more to turn Off the *Bluetooth*® Wireless Technology or Wireless LAN.

Preparing for Travel

With the right travel preparations, you can use the notebook anywhere you go, to prepare your business documents, confirm your travel plans, surf the Internet, or simply stay in touch with those back home!

Here is what you should do before you leave home:



Note

Speed the trip through airport security by carrying a charged notebook. Inspectors want to see the screen display a message. The boot message is usually sufficient. If your notebook is fully charged, the inspection only takes a minute or so. Otherwise, be prepared to attach the AC adaptor and power cable. And if you don't have these, the inspection might include a disassembly of the notebook.

- Back up your notebook's hard disk.
- Insert a fully charged battery to ensure your notebook is ready to quickly boot up at the airport security check.
- Fully charge all your batteries.
- Tape your business card to your notebook, AC adaptor, and batteries.
- If you run your notebook with battery power, maximise battery life by using power-saving features whenever possible.
- Take along any application or data files on diskette that you might need.
- Check that you have everything you need before you leave on a trip.

What To Take

The following are what you should take with you when you travel with your notebook.

- Extra fully charged batteries.
- Single-outlet surge protector.
- Appropriate AC plug adaptor for international voltage requirements.
- AC extension cord.
- Extra phone cord to reach wall jacks.
- A copy of "proof of purchase" for your notebook and other equipment or customs registration form for customs check.
- The Warranty Card or Service and Warranty Guide, detailing the international technical support phone numbers.
- Your notebook's Quick Reference.

Power Connections

With the right accessories, you can run your notebook almost anywhere! Your notebook self-adjusts to various power sources. The United States, Canada and most of Central and South America use 120-volt AC. Most other countries of the world use 240-volt AC. Make sure the power source falls within the system compatible range.

There are a few countries with areas that use DC as their main power source. You need a DC-to-AC converter in particular areas of Argentina, Brazil, India, Madeira and South Africa.

To use your notebook outside of your country, you need an adaptor plug. There are several different plugs available worldwide. You can buy these at an electronics supply store.

Getting Through Customs

With so many countries in the world, you can be sure that there are a variety of customs regulations. Plan wisely to get your notebook through customs by carrying the appropriate documentation to assure the customs agent that your notebook is not a recent purchase.

Travellers are often asked, when returning to their home country, whether or not they purchased the notebook while outside the country. Sometimes, the proof of purchase such as a bill of sale, insurance policy, or purchase receipt is sufficient. Taking along the purchase receipt for your notebook may sound practical, but may not always suffice, particularly when the purchaser of the notebook is your company and the original receipt is not available to you.

Connecting / Using Your Modem

Whether you are on a business trip or on holiday, connecting to the Internet while you travel can be expensive and frustrating unless you are prepared.

Here are some tips on how to avoid frustration and expenses while on the road.

1. Before leaving home, check with your Internet Service Provider to see if it has:
 - a local access number at your point of destination.
 - a toll-free number that can also save you money.
 - in the absence of a local ISP access number or toll-free number, charging the call to your home phone can be less expensive than charging the call to your hotel room.
2. Prepare your notebook for phone line access in another country.
 - Line access outside of a hotel may require an additional digit preceding the phone number string. Be sure to modify your dial-up connection, as required.
 - To avoid unusual dialling tone sounds sometimes encountered in hotels, you may have to modify a modem configuration setting to ignore the dialling tone.
3. Always check the phone line to determine whether or not it is digital or analogue. The internal modem in your notebook has built-in protection that detects the presence of a digital phone line and displays a warning message to alert you.

Connecting / Using a LAN

Many hotels and Convention Centres now offer direct Internet access for a nominal fee. If your hotel provides this service, follow these guidelines for connecting and configuring your notebook.

Many hotels can provide a LAN cable by prearrangement, so you can travel with a minimum of accessories.

1. Plug the LAN cable into your notebook and the LAN connector in the room or hall where you want to access the Internet.
2. After connecting the LAN cable, connect your notebook to an AC power outlet (if desired) and power on your notebook.
3. Try launching your browser (Windows® Internet Explorer®, or *Mozilla Firefox*, for example):
 - If your TCP/IP network settings are already configured to "Use DHCP for WINS Resolution" you should be able to access the Internet.
 - If your TCP/IP network settings are not set to use DHCP, a help screen may appear, or you may be directed to call the LAN provider for assistance configuring your notebook.

Follow the instructions that are provided to you completely, so your settings work effectively with the provider's system.

Connecting / Using a Wireless LAN

Many places now have a wireless network which you can connect to. Ask the provider for instructions or follow the guidelines below.

1. Tap your Wireless LAN multimedia sensor once to turn it On.
2. The notebook will automatically detect and attempt to connect to a wireless network. If there are more than one networks, it will connect to the strongest signal.
3. Wait for your notebook to show you that it is connected. Usually the LED will stop blinking and hold a steady light when this happens.
4. Try launching your browser (Windows® Internet Explorer®, or *Mozilla Firefox*, for example):
 - If your TCP/IP network settings are already configured to "*Use DHCP for WINS Resolution*" you should be able to access the Internet.
 - If your TCP/IP network settings are not set to use DHCP, a help screen may appear, or you may be directed to call the LAN provider for assistance configuring your notebook.

Follow the instructions that are provided to you completely, so your settings work effectively with the provider's system.

Using Peripheral Devices

USB Devices

USB ports allow you to connect USB-equipped peripheral devices such as a digital camera, scanner, printer, CD-ROM drive, modem, mouse, keyboard, telephone, or game device to your notebook.

USB devices called USB hubs can serve as connection ports for other USB peripherals. Only one device needs to be plugged into your notebook. Additional peripherals can be connected in a daisy chain configuration where one device is connected to another in a series.



Note

Some USB devices draw their power from the notebook power system, thereby reducing battery life. Always connect your notebook to an AC power source before connecting these devices.

Connect an external USB device to your notebook as follows.

1. Locate any of the USB ports on your notebook.
2. Follow any specific set-up instructions in the device's user's guide.



Note

USB devices can be hot-swapped or plugged, meaning that you do not need to turn off your notebook before plugging or removing USB devices.

3. Plug the USB device into one of the USB ports.

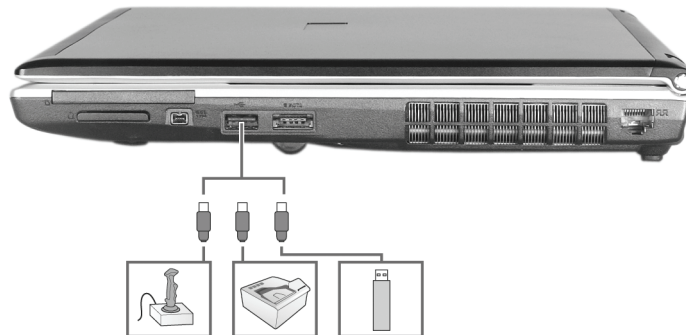

Note

Refer to the device's documentation for any additional instructions, if supplied.

Audio

Entertainment-level sound quality is provided through internal stereo speakers.

Audio Controls on your Notebook

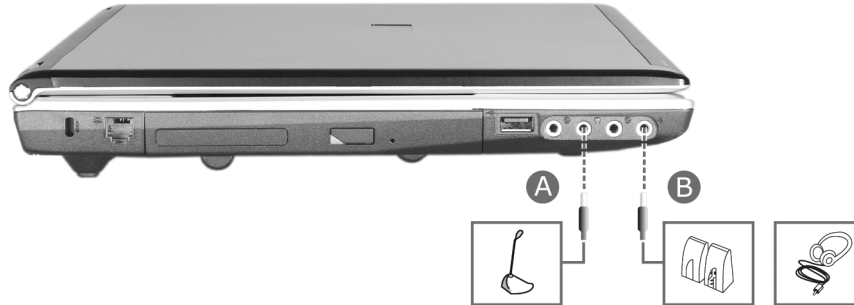

- **Microphone In Jack (A)** - allows you to connect an external microphone.
- **Headphones (B)** - lets you plug in stereo headphones or powered speakers.



Note

If you are using external speakers or an external microphone and experience sound distortion or feedback, lower the volume. Having the microphone and speakers too close to each other causes some feedback, so moving the external audio option away from the unit may also help.

Video

The superior resolution of the LCD screen allows for sharp effective visuals right on the notebook.

Using Digital Video Files

The IEEE 1394 port allows you to plug any video device, including VCRs, televisions, camcorders and laser disc players into your notebook and record motion graphics to your hard drive.

For more information, please refer to: **Frequently Asked Questions** → **Digital Video and IEEE 1394 Devices** in this Electronic User's Guide.

Page
80

Playing DVDs

The DVD-ROM or DVD/CD-RW combination drive (depending on your notebook configurations) allows you to watch movies recorded on DVDs directly on your notebook.

Using Animation Files

You can create a dynamic presentation using an animation application. Animation can illustrate a concept, drive home an important point, or command attention. Graphics animation can add punch to a presentation with an animated illustration, a flashing arrow, or a flying logo.

Setting Up a Healthy Work Environment

- **Arrange Your Equipment**
 - **Your Chair**
 - **Your Desk**
 - **Your Input Devices**
 - **Your Screen or Monitor**

- **Reducing the Risk of Injuries**
 - **Vary Your Workday**
 - **Practise Some Stretching Exercises**

- **Potential Medical Conditions**
 - **Repetitive Strain Injury**
 - **Pre-Existing Conditions and Psychosocial Factors**
 - **Epilepsy Warning**

Arrange Your Equipment

You will find below explanations on how to set up your notebook to fit your physical needs. This information is based on ergonomics - the science of making the workplace fit the needs of the worker.



WARNING

Prolonged or improper use of a computer workstation may pose a risk of serious injury. To reduce your risk of injury, set up and use your notebook in the manner described below. Please note that some people are more susceptible to developing these disorders due to pre-existing conditions or psychosocial factors, and that precautions can be taken in order to prevent physical discomfort.

For more information, please refer to: **Setting Up a Healthy Work Environment** → **Reducing the Risk of Injuries** ; and

**Page
65**

Setting Up a Healthy Work Environment → **Potential Medical Conditions** in this Electronic User's Guide.

**Page
66**



Note

To increase your comfort and safety when using your notebook as your primary computer system at your home or office, note the following recommendations:

- Use a separate, external keyboard attached to your notebook.
- Use a separate, external monitor attached to your notebook.

Arrange your equipment so that you can work in a natural and relaxed position. Place items that you use frequently within easy reach. Adjust your workstation set-up to the proper height (as described below) by lowering the table or stand that holds your notebook equipment or raising the seat height of your chair. Position your notebook directly in front of you for increased safety and comfort.

Your Chair

Your chair should be adjustable and stable. Vary your posture throughout the day.

Check the following:

- Keep your body in a relaxed yet upright position. The backrest of Use the entire seat and backrest to support your body. Tilt the backrest slightly (90° to 105°). The angle formed by your thighs and back should be 90° or more.
- Your seat depth should allow your lower back to comfortably contact the backrest. Make sure that the backs of your lower legs do not press against the front of the chair.
- Extend your lower legs slightly so that the angle between your thighs and lower legs is 90° or more.
- Place your feet flat on the floor. Only use a footrest when attempts to adjust your chair and workstation fail to keep your feet flat.
- Be sure that you have adequate clearance between the top of your thighs and the underside of your workstation.
- Use armrests or forearm supports to support your forearms. If adjustable, the armrests or forearm supports should initially be lowered while all the other adjustments discussed in this section are made. Once all these adjustments are completed, raise the armrests or adjust the forearm supports until they touch the forearms and allow the shoulder muscles to relax.



Your Desk

There is no specific height recommended for your desk. This can vary between 60 and 70 cm, depending upon your size. The standard workaround is that it should be at approximately your elbow height.

The desktop should be clean and organised in such a way that frequently used objects are close enough without excessive reaching. If you use a document holder, it should be placed at approximately the same height as the monitor and at the same distance from the eyes to prevent frequent eye shifts.

The area underneath the desk should be clean to accommodate your legs and allow for stretching.

Your Input Devices

Note the following points when positioning your notebook or any external input devices.

- Position your keyboard directly in front of you. Avoid reaching when using your keyboard or mouse.
- If you use a mouse, position it at the same height as the keyboard and next to the keyboard. Keep your wrists straight and use your entire arm when moving a mouse. Do not grasp the mouse tightly. Grasp the mouse lightly and loosely.
- Adjust the keyboard height so that your elbows are near your body and your forearms are parallel to the floor, with your forearms resting on either armrests or forearm supports, in the manner described previously. If you do not have armrests or forearm supports, your upper arms should hang comfortably at your sides.
- Adjust the keyboard slope so that your wrists are straight while you are typing.
- Type with your hands and wrists floating above the keyboard. Use a wrist pad only to rest your wrists between typing. Avoid resting your wrists on sharp edges.
- Type with your wrists straight. Instead of twisting your wrists sideways to press hard-to-reach keys, move your whole arm. Keep from bending your wrists, hands, or fingers sideways.
- Press the keys gently; do not bang them. Keep your shoulders, arms, hands and fingers relaxed.

Your Screen

Correct placement and adjustment of the screen can reduce eye, shoulder, and neck fatigue. Check the following when you position the screen.

- Adjust the height of your screen so that the top of the screen is at or slightly below eye level. Your eyes should look slightly downward when viewing the middle of the screen.
- Position your screen no closer than 30 cm and no further away than 75 cm from your eyes. The optimal distance is between 35 cm and 45 cm.
- Rest your eyes periodically by focusing on an object at least 6 metres away. Blink often.
- Position the screen at a 90° angle to windows and other light sources to minimise glare and reflections. Adjust the screen tilt so that ceiling lights do not reflect on your screen.
- If reflected light makes it hard for you to view your screen, use an anti-glare filter.
- Clean your screen regularly. Use a lint-free, non-abrasive cloth and a non-alcohol, neutral, non-abrasive cleaning solution or glass cleaner to minimise dust.
- Adjust the screen brightness and contrast controls to enhance readability.

- Use a document holder placed close to the screen.
- Position whatever you are looking at most of the time (the screen or reference material) directly in front of you to minimise turning your head while you are typing.
- Get regular eye check-ups.

Reducing the Risk of Injuries

Prolonged or improper use of a computer workstation may pose a risk of serious injury. To reduce your risk of injury, set up and use your notebook in the proper manner described. Please note that some people are more susceptible to developing these disorders due to pre-existing conditions or psychosocial factors.

For more information, please refer to: **Setting Up a Healthy Work Environment**
→ **Potential Medical Conditions** in this Electronic User's Guide.

Page
66

The precautions described below can however be taken in order to prevent physical discomfort.

Vary Your Workday

If you use your notebook for prolonged periods, follow these instructions.

- Vary your tasks throughout the day.
- Take frequent short breaks that involve walking, standing, and stretching. During these breaks, stretch muscles and joints that were in one position for an extended period of time. Relax muscles and joints that were active.
- Use a timer or reminder software to remind you to take breaks.
- To enhance blood circulation, alter your sitting posture periodically and keep your hands and wrists warm.

Practise Some Stretching Exercises

The daily exercises described below can be very effective in stopping Repetitive Strain Injury development or in minimising its effects. They can easily be carried out behind your notebook.

- **Bend wrists, stretch and close fingers** - stretch your arms and wrists with closed fingers; keep this pose for 8 seconds. Repeat the exercise 3 times. You can repeat the same exercise with your finger stretched.
- **Lift shoulders** - lift your shoulders straight up, hold that pose for 8 seconds and repeat the exercise 3 times.
- **Rotate shoulders** - rotate both your shoulders clockwise and counter-clockwise for 8 seconds. Repeat this exercise 3 times.
- **Stretch neck and shoulders** - bend your head to the left, right, front and back. Keep each position for 8 seconds. Repeat this exercise 3 times.
- **Stretch the flexors** - fold your hands into a praying position; palms flat against each other in front of your chest. Pull your hands gently downwards along your chest towards the stomach, keeping the elbows in the same position. Repeat the exercise 3 times and keep the pose for 8 seconds.
- **Stretch the extensors** - stretch your arm straight forward. Rotate your wrist 90 degrees up towards you and keep your thumb down, so that your other fingers are all pointing upwards (your hand should look like it is held out, telling someone to stop). Grab your four fingers pointing upwards with your other hand, and gently pull them towards you, while keeping your arm straightened. Hold this pose for 8 seconds and repeat this exercise 3 times.

Potential Medical Conditions

Computers are used everywhere. More and more people sit in front of computers for longer periods of time. Some nerve, tendon and muscle disorders (musculoskeletal disorders) may be associated with repetitive activities, improper work environments, and incorrect working habits. Examples of musculoskeletal disorders that may be associated with certain forms of repetitive activities include: carpal tunnel syndrome, tendinitis, tenosynovitis, de Quervain's tenosynovitis and trigger finger, as well as other nerve, tendon and muscle disorders.



WARNING

Prolonged or improper use of a computer workstation may pose a risk of serious injury. To reduce your risk of injury, set up and use your notebook in the proper manner described. Please note that precautions can be taken in order to prevent physical discomfort.

For more information, please refer to: **Setting Up a Healthy Work Environment** → **Reducing the Risk of Injuries** in this Electronic User's Guide.

Page
65

Although some studies have shown an association between increasing hours of keyboard use and the development of some musculoskeletal disorders, it is still unclear whether working at a notebook causes such disorders. Some doctors believe that using the keyboard and mouse may aggravate existing musculoskeletal disorders.



Note

Contact a doctor if you experience pain, tenderness, swelling, burning, cramping, stiffness, throbbing, weakness, soreness, tingling and/or numbness in the hands, wrists, arms, shoulders, neck, back and/or legs.

Repetitive Strain Injury

Repetitive Strain Injury is caused by a constant tension of the muscles in your arms and by making the same repetitive movements with fingers, wrist and elbow when controlling the mouse. The symptoms are pain and stiffness in neck, shoulders, arms, wrists and hands. Other symptoms are cramps, tingling and exhaustion in these areas.

The Three Stages of Repetitive Strain Injury

Real Repetitive Strain Injury pain implies that the problems have persisted for a longer period of time, normally for a minimum of three months. The development can be divided into three stages:

- Stiffness, numbness, irritation, sometimes in combination with light or sharp pains. These problems disappear, but return when similar work is done.
- The problems do not disappear overnight. Continuous light pain, also after a period of rest. After a longer period of rest (holidays) the pain does go away, but returns easily when similar work is done.
- Continuous pain often combined with reduced strength and less accurate control. At work, the pain intensifies. When rested, the pain remains.

Pre-Existing Conditions and Psychosocial Factors

Pre-existing conditions that may cause or make some people more susceptible to musculoskeletal disorders include the following: hereditary factors, vascular disorders, obesity, nutritional deficiencies such as Vitamin B deficiency, endocrine disorders such as diabetes, hormonal imbalances, connective tissue disorders such as arthritis, prior trauma (to the hands, wrists, arms, shoulders, neck, back, or legs), prior musculoskeletal disorders, aging, fluid retention due to pregnancy, poor physical conditioning, dietary habits and other conditions.

Psychosocial factors associated with these disorders include: workplace stress, poor job satisfaction, lack of support by management and/or lack of control over one's work.

Contact a doctor if you experience pain, tenderness, swelling, burning, cramp, stiffness, throbbing, weakness, soreness, tingling and/or numbness in the hands, wrists, arms, shoulders, neck, back, and/or legs.

Epilepsy Warning

Some people are susceptible to epileptic seizures or loss of consciousness when exposed to certain flashing lights or light patterns in daily life. Such people may have a seizure while watching television images or playing certain games. This may happen even if the person has no medical history of epilepsy or has never had any epileptic seizures.

If you or anyone in your family has ever had symptoms related to epilepsy (seizures or loss of consciousness) when exposed to flashing lights, consult your doctor prior to playing games with such features. We advise that parents monitor the use of games by their children. If you or your child experience any of the following symptoms such as dizziness, blurred vision, eye or muscle twitches, loss of consciousness, disorientation, any involuntary movement or convulsion while playing a game, IMMEDIATELY discontinue use and consult your doctor.

Problem Checklist

First check the items in the following list. If these items don't help, see the table that follows the list.

- Power to the notebook is on.
- The AC power outlet to which your AC adaptor is connected is working. Test the outlet by plugging in a lamp or other electrical device.
- All cables are tightly connected.
- The display setting is configured correctly.
- The display brightness control is adjusted properly.
- If using battery power, check that the battery pack is properly inserted and fully charged.

Problem	Resolution
The notebook does not power on	<p>If you are operating the notebook with battery power, check that the battery pack is correctly inserted. Attach the AC adaptor to recharge the battery.</p> <p>If you have the AC adaptor attached, check that you are using a working AC power outlet.</p>
LCD screen is dark and blank	<p>Power-saving mode has shut off the backlight. Press a keyboard key. The built-in LCD may not be selected. Press specific function key once or twice to select the LCD video mode.</p> <p>Screen brightness needs adjustment. Use the specific functions keys. The notebook entered Standby mode due to low battery power. Plug in the AC adaptor before resuming operation.</p>
Battery power does not last long	<p>Use power-saving modes.</p> <p>For more information, please refer to: Windows Vista® Operating System Introduction → Managing System Power in this Electronic User's Guide. Page 31</p> <p>Fully charge and discharge the battery several times to recondition it. Replace the battery.</p> <p>For more information, please refer to: Introducing Your NEC VERSA → Using the Battery ; and Introducing Your NEC VERSA → Replacing the Battery in this Electronic User's Guide. Page 21 Page 23</p>
Information on the LCD is difficult to see	<p>Use the specific functions keys to adjust the brightness control.</p> <p>Tilt the LCD screen slightly forward or backward.</p>
An optional component does not work	<p>Make sure the component is securely installed or connected.</p> <p>Refer to the optional component documentation.</p>
The Standby/Resume function does not work.	<p>If the notebook does not enter Standby mode, a disk drive might be busy. Wait until the disk drive stops and try again.</p> <p>If notebook does not resume, it may have auto suspended on a low battery. Attach the AC adaptor and try again.</p>

Start-Up Problems

A built-in checking program will automatically test its components when you turn the notebook power on. This diagnostic test is called the Power-On Self-Test (POST). If the notebook finds a problem during the POST, the notebook displays an error message or emits a series of beep codes when there are the following conditions:

- the current configuration information doesn't match configuration information stored in Auto Setup, such as when an internal option is added.
- the notebook loses configuration information.

If You Need Assistance

If you have a problem with your notebook, first review the "Problem Checklist" troubleshooting table and the "Start-Up Problems" troubleshooting table. You may also want to check out the section on "Frequently Asked Questions".

Frequently Asked Questions in this Electronic User's Guide.

**Page
75**

Recovery Information for Windows Vista®

NEC Recovery Program (from backup partition)

There is a backup partition on the hard disk drive which contains all the data you may need in order to restore your configuration as it was when leaving the factory. This partition occupies about 10 GB of your hard disk drive.



Note

This backup partition is hidden.

The NEC Recovery Program can restore your notebook to the same state as when you purchased it, while giving you an option to retain all settings and personal data for later retrieval.

Due to the wide range of reasons for which the NEC Recovery Program may be used, no guarantee can be given that all data will be retained.

The procedure described below is only applicable if your backup data is stored on your notebook's hard disk. If you wish to restore your notebook using Recovery DVD, please refer to notes below.

You are strongly recommended to create a set of Recovery DVDs for future use.

Be ready with 2 blank DVD-Rs. Please use the **MDVDCreator** tool. Click the **Start** button



, click **All Programs**, then click **MDVDCreator**



to launch the **MDVDCreator** program. It will then guide you through the process.

Before you run the **MDVDCreator** program, you need to disable the **UAC** (User Account

Control). To do this, click the **Start** button , click **Control Panel**, select **User Accounts**, then click **Turn User Account Control on or off**. Then uncheck the "Use User Account Control (UAC) to help protect your computer" box. Click **OK**.



CAUTION

Before using the NEC Recovery Program it is recommended that you **FIRST** try fixing your computer with Windows Vista® System Restore.

System Restore can be used to restore your computer to a previous state when it was known to function correctly, without affecting your personal data files (such as documents, browsing history, drawings, favourites, or e-mails).

The NEC Recovery Program Allows Two Types of Recovery

- **Full Recovery**

Removes all your personal data and restores your notebook to its original factory state. By using this option, all your data will be lost (personal documents and settings, and driver updates).

- **Partial Recovery**

Restores your original operating system and software to their original factory state without deleting your personal data.



CAUTION

After recovery, all software titles that you have installed on your computer must be reinstalled before you can use them again. Only the pre-installed titles (such as DVD Players and CD-writers) will function without additional installation.

IMPORTANT

Please read this section carefully before using NEC Recovery Program!

- **Backup your personal files:**

Save a copy of your personal documents onto floppy disks, memory cards or high capacity disks. If you own a CD writer, you can backup larger amounts of data and create your own archives.

- **Return your notebook to its original configuration:**

1. Remove any additional hardware components (such as sound card, video card and network card) that you may have added to your notebook.
2. Reinstall the original NEC hardware components if you have removed them.
3. Make sure that your keyboard, mouse, monitor and speakers are connected properly (if applicable to your notebook).
4. Disconnect any additional devices that you have connected to your notebook (such as scanner and printer).

Starting the NEC Recovery Program

Before starting the NEC Recovery Program, please make sure your notebook is in AC mode.

To launch the NEC Recovery Program:

6. Press the **<F8>** key while your system is still booting.
7. Select **"Repair Your Computer"** at the Advanced Boot Options page.

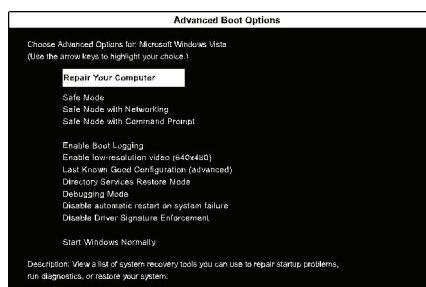

8. Select your preferred keyboard layout. Then click "Next".

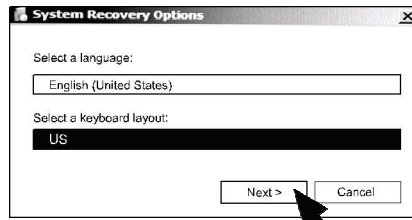

9. Set your "Username" & "Password" (if available). Then click "OK".

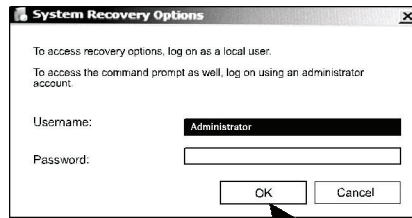

10. At System Recovery Options, choose "NEC Recovery Tools".

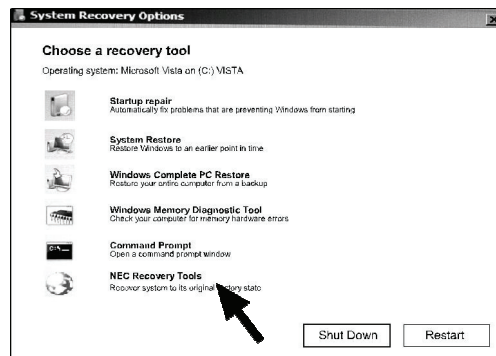

11. Click "Next" to continue.



12. Select either **Partial Recovery** or **Full Recovery**. Then click **Next** to continue.

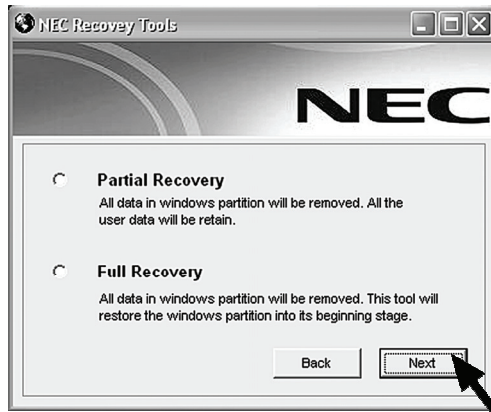

13. Click **OK** to continue.



14. Click **Start** to start the recovery process.

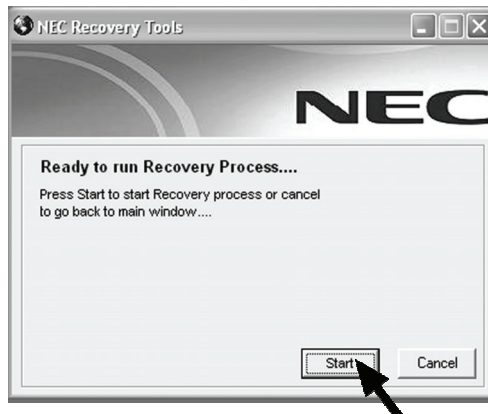

Please wait for the recovery process to be completed.

15. The NEC Recovery tools application will close automatically after the recovery is completed.

16. Finally, you have to restart your notebook by clicking the **Restart** button at System Recovery Options.

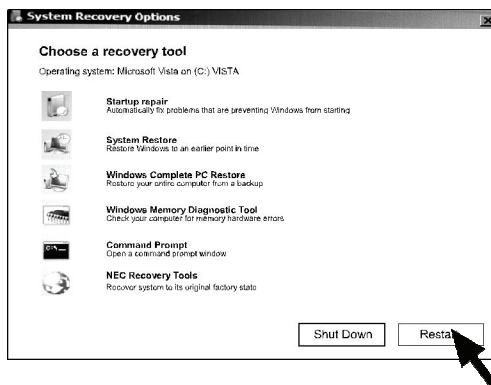

If You Wish to Perform a Full Recovery:



CAUTION

Full Recovery will remove all your personal data and restore your computer to its original factory state.

Select **Full Recovery** and click on **Next**. Then follow the on-screen instructions to complete the recovery.

If You Wish to Perform a Partial Recovery:

1. Select "**Partial Recovery**" and click on "**Next**".
2. Follow the on-screen instructions to complete the recovery.



Note

There may be a delay the first time Windows® restarts after the recovery process. This delay depends on the amount of data that must be retrieved from the selected account.

3. After the Partial Recovery process has been completed and if you have used default Windows® settings, you may retrieve your data in the following locations:

- **Your Documents and Settings:**

C:\user\[Previous User Name]\...

- **Applications:**

C:\Program Files\[Application Name]\...

- **Other files:**

You can use the Windows® Search Engine to find other files.



CAUTION

You should consider deleting items on the desktop and in the Start Menu, and also folders for applications you no longer wish to use.

DO NOT delete folders for software that you did not originally install yourself – they may contain important Windows® files.

4. Finally, reinstall software titles you wish to use.

Frequently Asked Questions

- **Technical Support**

- **Where can I find the call centre phone number?**

- **Boot Problems**

- **The message "Operating System Not Found", or "Non-System disk or disk error" appears during boot-up.**
- **Why can't I boot from the floppy disk drive?**
- **What is the difference between a warm boot and a cold boot?**
- **Why does my notebook automatically boot up when I receive a phone call?**

- **Computer Viruses**

- **When did a virus appear for the first time?**
- **What is a computer virus?**
- **Is my notebook virus-free?**
- **What are the different types of viruses?**
- **What can I do to keep my notebook virus-free?**

- **Internet**

- **How do I connect to the Internet?**
- **How do search engines work?**
- **How can I narrow down a search on the Internet?**
- **What are the cookies?**
- **Are cookies a threat to privacy?**
- **Can a virus attach itself to cookies?**

- **IEEE 1394 Devices and Digital Video**

- **IEEE 1394 Devices**
 - **What are the benefits of the IEEE 1394 port?**
- **Digital Video**
 - **What is the Digital Video (DV) format?**
 - **What are the benefits of Digital Video?**

These Frequently Asked Questions are common to a wide range of notebooks; please note that some may not be relevant to your notebook.

Technical Support

If you are not able to resolve your problem you can contact NEC Customer Support. Please check the terms of your warranty, and have your notebook's serial number on hand before you call us. Please write down any error message causing the problem, and have the notebook in front of you, switched on if possible.

Boot Problems

The message "Operating System Not Found", or "Non-System disk or disk error" appears during boot-up.

This message implies that your notebook cannot find any operating system on the first boot media.

For more information, please refer to: **Introducing BIOS Setup for Windows Vista®** in this Electronic User's Guide.

Page
26

Most of the time, this happens because a non-bootable diskette is inserted in the floppy disk drive, and the notebook unsuccessfully tries to boot on this diskette. Remove the floppy disk (you do NOT need to insert a bootable floppy disk instead) and follow the on-screen instructions.

Why can't I boot from the floppy disk drive?

To boot from the floppy disk drive, be sure that you have a floppy disk in the drive containing operating system files (also known as bootable floppy or system floppy). Be sure to check the boot sequence in the **BIOS Setup chapter**. See your operating system documentation for information on how to create a system floppy.

What is the difference between a warm boot and a cold boot?

A warm boot restarts the notebook while system power is on. This process resets the software by clearing the volatile system memory and reloading the operating system.

A cold boot is a notebook start with power off. This process resets and checks the hardware, and reloads the operating system.

Why does my notebook automatically boot up when I receive a phone call?

Make sure your BIOS parameters are correctly set up.

For more information, please refer to: **Introducing BIOS Setup for Windows Vista®** in this Electronic User's Guide.

Page
26

Computer Viruses

When did a virus appear for the first time?

There are theories that experiments with virus-like self-replicating programs already took place in 1949. Experimental viruses were first programmed and tested in the 1960s. The name "virus" first popped up in 1984 when a university professor used this term to describe the destructive computer programs. When personal computers became popular in the 1980s, computer viruses also started appearing. The use of floppy disks and bulletin boards in the late eighties and the excessive growth of the Internet and computer usage at home and in businesses in the late nineties increased the number of viruses and infected computers. Today's viruses may also take advantage of network services such as the World Wide Web, e-mail, instant messaging and file sharing systems to spread. Widely used new storage media such as USB thumbdrives also put users at risk.

What is a computer virus?

Computer viruses are man-made and share some of the behaviours of biological viruses. A computer virus passes from computer to computer like a biological virus passes from person to person. Similarities also exist at a deeper level: a biological virus is not a living thing and has to reproduce itself by infecting cells. A computer virus must be transmitted on top of some other program or document in order to get executed. Once running, it is then able to infect other programs or documents.

Is my notebook virus-free?

Most viruses have strange effects on your notebook. On the other hand, many viruses are carefully programmed to avoid betraying their presence. The solution to this dilemma is not to assume anything, but to rely upon antivirus software as a diagnostic tool.

What are the different types of viruses?

- **Boot sector viruses** - a boot sector virus infects your notebook by replacing the boot sector program with its own infected version. The boot sector program is the first piece of software that is loaded when you start your notebook. It is installed on every hard disk, floppy disk or CD. Without a boot sector, a notebook cannot run any software at all. A boot sector virus will only be effective if you start your notebook using an infected floppy disk or an infected bootable CD. An example of a boot sector virus is "Parity Boot". This virus displays the message "PARITY CHECK" and freezes the operating system.
- **Macro viruses** - a macro is an instruction that carries out program commands automatically. Many common applications like Microsoft® Word and Microsoft® Excel make use of these macros. Macro viruses are macros that self-replicate. If a user accesses a document containing a viral macro, the macro virus will be executed. Any document on that machine using the same application can then become infected. The infection process only ends when the virus is noticed and all viral macros are eradicated.
- **Worms** - these are the most popular types of viruses. They infect your notebook through e-mail. If you double-click on the attachment in such a mail, the virus starts sending mail to all the entries in your e-mail program's Address Book. This creates a lot of traffic on the Internet and slows down connection speed. A famous example is the Code Red worm, which replicated itself over 250,000 times in approximately nine hours on July 19, 2001.
- **Trojan Horse** - this type of computer virus disguises itself as a funny program, which you can download from the Internet. It can also present itself as an e-mail attachment. Once the program is running the virus will for instance format your hard drive. The famous "I Love You" virus is an example of such a virus. Trojan horses only hit a small number of people because they are discovered quickly.
- **Hoax** - a hoax is not a typical computer virus, but it can act as one. You may have already received an email from a friend warning you of a new virus. In most cases you are requested to forward this e-mail to all entries in your Address Book. Most of these warnings are a hoax and won't do any damage to your notebook. Computers users who are unaware of these hoaxes tend to forward such e-mail to others, thus creating a lot of traffic on the Internet and slowing down connection speed.

What can I do to keep my notebook virus-free?

An **antivirus program** is installed on your notebook. Keep this antivirus scanner up-to-date and running. It is capable of recognising and eliminating most kinds of viruses before they can do any harm. These programs have a tendency to get outdated, because new viruses appear each time. Most antivirus software enables you to download the latest virus definitions from their websites that will recognise the newest viruses. You will also find the latest news about viruses and hoaxes.

Some additional tips:

- Always be cautious when opening email attachments, even those coming from friends, co-workers or family members. Never open email attachments from strangers, delete them right away. You should also be careful when downloading files from websites. Only use websites that are trustworthy.
- Check all removable storage media such as floppy disks, CDs and USB flash drives carefully using a virus scanner before you start using them.
- Make backups of all your personal files. Should a virus "attack" your notebook, you will still have the backups.
- Do not use illegal copies of software protected by copyright.
- Perform a complete system scan regularly using an antivirus program and update it often.
- When your notebook is connected to a network, please make sure that only authorised persons have access to your notebook (you can use passwords and share files as "Read Only").
- Always use a personal Internet Firewall to help protect your notebook from attacks by viruses, trojans, worms and intruders.

Internet

How do I connect to the internet?

Windows® operating systems (if applicable) provides fully-integrated Internet experience. Use the *Internet Connection Wizard* on your desktop to configure your notebook for e-mail and Internet access. Sign up for a new account or configure your notebook to use an existing account.

Before using the *Internet Connection Wizard*, to transfer an existing account for e-mail and Internet access, you need an Internet service provider (ISP) account and some or all of the following configuration information:

- the dial-up telephone number
- TCP/IP settings
- port settings
- a user name/logon and password
- your e-mail address
- the name of a Post Office Protocol version 3 (POP3), Internet Message Access Protocol (IMAP), or Hypertext Transfer Protocol (HTTP) server (for incoming mail)
- the name of an Simple Mail Transfer Protocol (SMTP) server (for outgoing mail)

The *Internet Connection Wizard* offers the following choices:

- Sign-up for a new Internet account. Take advantage of the *Microsoft® Internet Referral Service*.
- Transfer an existing Internet account.
- Manually configure an Internet account or connect through a local area network (LAN).

For more information, please refer to: **Windows Vista® Operating System**
Introduction → **Tips for Using Windows Vista®** in this Electronic User's Guide.

Page
33

How do search engines work?

Searching the Web actually means searching intermediate databases since it is not possible to directly search the World Wide Web, which contains an estimated 1 billion documents. The Web is the totality of web pages found in computers (called "servers") worldwide.

Search engines use software or robot programs (called "spiders") to search the Net for documents and the corresponding addresses (Uniform Resource Locator). These documents and web addresses are then collected in the search engine's indexing software. The indexing software, after getting information from the documents, stores the information in a database. Indexing the information varies depending on the type of engines. Some engines index key words in a document while others index the document title. When you perform a search, the database is being searched for documents that match, and the results are displayed on a web page.

There are two main categories of Internet search tools:

- **Search engines and meta-search engines** work by processing the search terms you type in and listing the possible web sites that can be found under that subject. Examples of search and meta-search engines are AltaVista and Metacrawler.
- **Subject directories display by categories.** These categories are organised into hierarchies or a list from generic to specific topics. Yahoo is an example of a subject directory where links are sorted in hierarchical structure.

How can I narrow down a search on the Internet?

- **Use several key words** - if you are searching for 1980s pop music, use the key words "music" and "80s" in your search for better results. Be sure to spell the words correctly to minimise getting an error page.
- **Be as specific and precise as possible** - like searching a library catalogue, the more specific the search is the more effective it will be.
- **Be careful when using punctuation marks** - some users search by typing a question. For example: "What is 80s music?" This option allows the search engine to come up with several sites that may be of interest to the user. Compared to a target-specific search, this option has more flexibility by delivering a wider range of topics under 1980s popular music.
- **Speed up the search by using Boolean expressions** - these expressions are AND, OR, and NOT. The Boolean expressions can be used to connect words and phrases in a search request.
- **Use the '+', '-' signs** - for certain search engines, the signs '+', '-' before a word respectively include or exclude it. Do not include a space between these signs and the searched words.
- **Refer to the search engine's Help pages** - it may offer relevant tips or offer shortcuts that you might have missed. The Help pages also give a guide on how to properly use the engine and get better results.
- **Try using synonyms or re-phrasing the search** - for example, instead of "80s" you can use the word "eighties" or "lunar expeditions" for "moon expeditions." At the same time, try to refine the search by adding specific details.

What are the cookies?

A cookie is a small piece of information written to the hard drive of an Internet user whenever the user visits a Web site that offers cookies. Although cookies are tiny files (around 255 characters and 4k of disk space), it contain miscellaneous information such as the name of the Web site that issued them, pages viewed by the user, log-in names and credit card numbers that have been supplied via forms.

When information such as a name, hobbies and educational background is voluntarily provided to a Web site, the information is packaged into a cookie before it is sent and stored in the Web browser for later use. The next time you visit the same Web site, the browser sends the cookie to the Web server that uses the information, for example, to present you with customised pages.

Are cookies a threat to privacy?

A cookie is a simple piece of text and by itself represents no threat. Cookies cannot access the hard drive. The browser can save cookie values to the hard disk, but that is the most it can do to a notebook. On privacy, Net users can be as anonymous as they want to be. Besides, nobody can reveal personal information than the user himself. Web servers allow the tracking of surfing habits and other information that are released and collected. Cookies can be used as a tracking device, but a cookie does not have the capability to read the hard drive or find details of your lifestyle.

Can a virus attach itself to cookies?

Viruses attach themselves to program or executable instruction files, and most cookies are made up of or stored in text and data files. Computer experts say that a cookie has never hosted or spread a virus, and it is unlikely to happen because cookies do not have a feature that will make it easy for a virus to attach itself.

For more information, please refer to: **Frequently Asked Questions → Computer Viruses** in this Electronic User's Guide.

Page
76

IEEE 1394 Devices and Digital Video

The IEEE 1394 is also called FireWire® or i-link® on some electronic devices.

Certain software applications are specially designed to easily capture video from digital video cameras, computer cameras, and other sources.

IEEE 1394 Devices

What are the benefits of the IEEE 1394 port?

The IEEE 1394 multimedia connection enables simple, low-cost, high-bandwidth isochronous (real-time) data interfacing between computers, peripherals, and consumer electronics products such as camcorders, VCRs, printers, PCs, TVs, and digital cameras. With IEEE 1394-compatible products and systems, users can transfer video or still images from a camera or digital video camera to a printer, notebook, or television, with no image degradation.

During the analogue days, connecting a TV to a VCR, or playing back a movie from your camcorder to your TV was fairly easy. Then came the digital revolution. Historically, connecting digital devices together -especially high-speed devices- often meant special requirements, including software settings, device IDs, jumpers, switches, screws, latches and terminators. The IEEE 1394 standard works just like in the old analogue days; you plug in a cable and it works.

The IEEE 1394 standard defines its interface as:

- **Digital** - requires no conversion of digital data into analogue, implying better signal integrity.
- **Hot** plug - allows a device to be added and removed without turning off or rebooting the notebook.
- **Scalable** - supports multiple speeds.
- **Fast** - supports guaranteed delivery of time critical data, thus enabling high-quality audio and video applications.

Digital Video

What is the Digital Video (DV) format?

Digital Video is the preferred file format for high quality video, usually captured via a digital video camera. It is a super high-resolution format that exceeds the quality of S-VHS. The images are crisp, bright and have excellent depth and contrast. The information is stored on the video tape in digital form, so it can be copied over and over without any loss.

The DV standard defines all aspects of the so called "DV" or Digital Video camcorders, including tape recording format and form factor, video compression algorithms and also digital data transmissions.

What are the benefits of Digital Video?

A digital video camera actually puts professional video capabilities into the hands of just about everyone. Transferring your video to your notebook is made extremely simple, as is the actual editing of the video, thanks to specific software applications.

Safety Notices

- **Modem**
- **Modifications to the Product**
- **Radio Frequency Interference Statement**
- **Connections and Remote Earth**
- **Power Supply and Cables**
- **Batteries**
- **Laser Compliance Statement**
- **Thunderstorm Warning**
- **Radio-communication Regulation (if applicable)**
- **Additional Notices**
- **Electrostatic Discharge (ESD) and ESD Protection**
- **Product Storage Environment Guidelines**

Modem

Only use a modem that has been approved by the national authority of the country in which the product is sold. Technically and in most cases, the same modem should work in all countries. Nevertheless, be advised that some countries might have strict laws which forbid the modem from being used before it is technically approved. Kindly check this information with your dealer or get an approved modem as a replacement.

Modifications to the Product

Radio Frequency Interference

The manufacturer is not responsible for any radio or TV interference caused by unauthorised modifications to this equipment.

Safety Warning

The manufacturer is not responsible for any safety hazards caused by unauthorised modifications to this equipment.

Radio Frequency Interference Statement



WARNING

Changes or modifications to this unit not expressly approved by the party responsible for compliance could void the user's authority to operate the equipment. The manufacturer is not responsible for any radio or TV interference caused by unauthorised modifications to this equipment.



Note

This is a Class B digital device. This equipment has been tested and found to comply within the limits for a Class B digital device, pursuant to the CISPR22 Standard (CISPR is the acronym for the French name of the International Special Committee on Radio Interference, IEC). These limits are designed to provide reasonable protection against harmful interference in a residential installation. This equipment generates, uses and can radiate radio-frequency energy. If not installed and used in accordance with the instructions, it may cause harmful interference to radio communications.

There is no guarantee, however, that interference will not occur in a particular installation. If this equipment does cause harmful interference to the radio or television reception, which can be determined by switching the equipment on and off to check its effect on reception, the user is encouraged to try to correct the interference by applying one or more of the following measures:

- Reorient or relocate the receiving antenna.
- Increase the distance between the equipment and receiver.
- Connect the equipment to an AC power outlet on a circuit separate from the one to which the receiver is connected.

To meet the CISPR22 Standard, shielded cables and power cords are required when connecting this device to a personal computer or other Class B certified devices.

Connections and Remote Earth

Protected Extra Low Voltage (PELV)

To ensure the extra-low voltage integrity of the equipment, only connect equipment with mains-protected, electrically-compatible circuits to the external ports.

Safety Extra Low Voltage (SELV)

Each input and output of this product is classified as Safety Extra Low Voltage, except the modem, which is classified as TNV-3.

Remote Earth

To prevent electrical shocks, connect all local (individual office) notebooks and computer support equipment to the same electrical circuit of the building's wiring. If you are unsure, check the building's wiring to avoid remote earth conditions.

Building Supply

Only connect the equipment to a building supply that is in accordance with current wiring regulations in your country.

Power Supply and Cables

Depending on the model you purchased, some models may come with more than one type of power cord.

Please note the following identifications to ensure that you are using the right power cord in order to avoid electrical shock hazards.

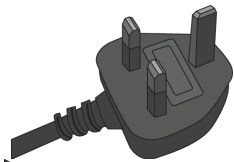

This power cord plug is suitable for use in **Malaysia, Singapore, Hong Kong, Bangladesh and Maldives.**

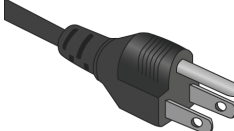

This power cord plug is suitable for use in **Thailand and Philippines.**

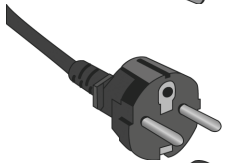

This power cord plug is **ONLY** suitable for use in **Indonesia, Mongolia and most countries in Europe except United Kingdom.**

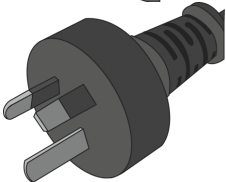

This power cord plug is suitable for use in **Australia and New Zealand.** The live and neutral pins have insulation as an extra safety precaution.



WARNING

Failure to use the correct power cords may result in electrical shock.

Power Supply

The power supply socket-inlet and socket-outlet (if equipped) are classified as Hazardous Voltage.

You must unplug the power supply cord to disconnect the equipment from the power supply. For this purpose, the socket-outlet should be installed as close to the equipment as possible and should be easily accessible.

In Europe, before plugging the power cord into an AC power outlet, check that the voltage selector switch of the computer's power supply (if available) is in position "230 V". In the U.S.A. and Canada, before plugging the power cord into an AC power outlet, check that the voltage selector switch of the computer's power supply (if available) is in position "115 V". In Asia, before plugging the power cord into an AC power outlet, check that the voltage selector switch of the computer's power supply (if available) is in position "230 V".

Under no circumstances should the user attempt to disassemble the power supply. The power supply has no user-replaceable parts. The power supply has hazardous voltages that can cause serious personal injury.

A defective power supply must be immediately returned to your dealer.

Power Cables

This equipment requires a 3-wire, grounded power cord. The cord length must not exceed 2.5 metres. To prevent electrical hazards, do not remove or disable the ground contact on the power cord. Replace the power cord if it gets damaged. Contact your dealer for an exact replacement. In Europe, the plug must be rated for 250 VAC, 10 amp minimum. In the U.S.A. and Canada, the plug must be rated for 125 VAC, 10 amp minimum. The plug must display an international agency approval marking. The cord must be suitable for use in your country. Consult your dealer or the local electrical authorities if you are unsure of the type of power cord to use in your country.

Cables

The EMC performance of the notebook is guaranteed only if the cable and interface use efficient shielding.

The use of shielded interface cable is required for USB, IEEE 1394, serial, printer, game, analogue or digital audio/video, Ethernet LAN, PS/2, TV or FM antennas, and generally all high speeds cable interfaces.

Only Ethernet LAN or RTC modem cables can have lengths exceeding 3 metres.

For Ethernet LAN cable, use FTP shielded cables only (Cat \geq 5).

Heat build-up

The AC adaptor and the underside of the notebook can become hot after prolonged use. Sustained physical contact with either should be avoided.

Batteries

Replacing batteries

A lithium-battery in some computers maintains system configuration information. In the event that the battery fails to maintain system configuration information, we recommend that you replace the battery. For battery replacement information, call your dealer or your Customer Assistance Centre.

Unauthorised repairs or replacement of battery cells or parts in a battery-pack will void the safety and fire warranty.



WARNING

There is a danger of explosion if the battery is incorrectly replaced. Replace only with the same or equivalent type recommended by the manufacturer. Discard used batteries according to the manufacturer's instructions.

Battery Disposal

The ultimate disposal of this product should be handled according to all national laws and regulations. Do not place used batteries in your regular waste: incineration, landfilling or mixing of batteries with municipal solid waste stream are prohibited by law in most countries.

Contact your local waste management officials for other information regarding environment-sound collection, recycling and disposal of used batteries.

Laser Compliance Statement

The optical devices are tested and certified to be compliant with the International Electro-technical Commission IEC825-1 and the European Norm EN60825-1 and the EN60825-2 regulations for Class 1 laser products.

Class 1 laser products are not considered hazardous. The optical devices are designed so that there is no risk of human exposure to laser radiation above a Class 1 level during normal operation or prescribed maintenance conditions.

The optical devices installed in your notebook are designed for use solely as components of such electronic products and therefore do not comply with the appropriate requirements of Code of Federal Regulation Sec. 1040.10 and Sec. 1040.11 for COMPLETE laser products.

Thunderstorm Warning

- This warning is only applicable if the product you purchased has a modem and/or TV- tuner. Similar precautions should be taken if you are connecting a modem or TV- tuner to the product.
- It is advisable to connect a telephone cable and/or an antenna cable to wall plugs which are equipped with lightning-surge protection. If this is unavailable, then avoid connecting both cables during thunderstorms.
- Always disconnect the telephone cable and/or the antenna cable even though the product is shut down or in standby mode.

Radio-communication Regulation (if applicable)

Specific regulations apply when using wireless radio-communication products.

Additional Notices

Each input or output of this product is classified as Safety Extra Low Voltage (SELV).

Electrostatic Discharge (ESD) and ESD Protection



WARNING

Electrostatic Discharge (ESD) can damage disk drives, cards, memory modules and other parts. We recommend that you carry out all procedures in this guide only at an ESD-workstation. If one is not available, provide some ESD protection by wearing an antistatic wrist strap attached to any unpainted metal surface when handling parts. If you do not have one, discharge static electricity from yourself and your clothing by touching a nearby metal surface before handling any internal components.

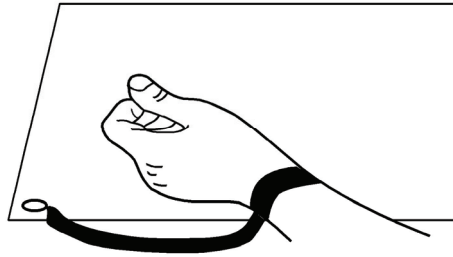

Product Storage Environment Guidelines

1. When the product is in use (or started up):
 - This product is best used in temperatures from 15°C to 25°C, although it will operate normally from 5°C to 35°C.
 - Avoid placing the product in a dusty environment as excessive dust might be sucked into the machine body, reducing its cooling efficiency.
 - Do not try to block any ventilation holes as you may cause the product to over-heat.
 - Do not place the product in a humid environment to avoid rusting or corrosion due to excessive water vapourisation.
2. When the product is shut down.
 - Avoid placing the product for a prolonged time in hot environments (with an excessive temperature of above 60°C) as that can damage the LCD panel or cause the battery pack to explode or leak.
 - If you plan to keep the product unused for a long period, do charge the battery to full capacity and then disconnect the battery pack before putting the notebook in storage.
 - Avoid placing the product in extreme cold conditions (below 0°C).

Recommended Environment

Operation

- Temperature: 5°C to 35°C
- Relative Humidity: 10% to 80% (Non-condensing)
- Gradient: 10°C/hr

Glossary

Term	Definition
AACS	Advanced Access Content System
AC	Alternating Current
ACPI	Advanced Configuration and Power Interface
ALS	Automatic Light Sensor
BIOS	Basic Input/Output System
CD	Compact Disc
CPU	Central Processing Unit
DC	Direct Current
DSL	Digital Subscriber Line
DV	Digital Video
DVD	Digital Versatile Disc
ECO	Economy Mode
E-SATA	External Serial Advanced Technology Attachment
ESD	Electrostatic Discharge
GB	Gigabyte (1,000,000,000 bytes)
HDD	Hard Disk Drive
HDMI	High Definition Multimedia Interface
HTTP	Hypertext Transfer Protocol
IEEE 1394	Institute of Electrical and Electronics Engineers Interface 1394
IMAP	Internet Message Access Protocol
ISP	Internet Service Provider
LAN; Wireless LAN	Local Area Network; Wireless Local Area Network
LCD	Liquid Crystal Display
LED	Light-Emitting Diode
Li-Ion	Lithium-Ion
MMC	Multimedia Card
MS	Memory Stick/Memory Stick Pro
PC	Personal Computer
POP3	Post Office Protocol Version 3
POST	Power-On Self-Test
PELV	Protected Extra Low Voltage
SD	Secure Digital/Secure Digital High Capacity
SELV	Safety Extra Low Voltage
TV	Television
UAC	User Account Control
UPS	Uninterruptible Power Supply
USB	Universal Serial Bus
VCR	Video Camera Recorder
VGA	Video Graphics Array
xD	xD-Picture Card

This original copy of the agreement is your proof of license. Please treat it as valuable property.

NEC Computers Asia Pacific Sdn. Bhd. License Agreement

IMPORTANT-READ CAREFULLY BEFORE USING SOFTWARE OR OPENING SOFTWARE PACKET(S).

Unless a separate multilingual license booklet is included in your product package, the following license Agreement applies to you. Please take note that some third party software supplied to you may be covered by other license agreements. Please refer to all the relevant license agreements provided for important terms and conditions applicable to such software.

This is a legal and binding Agreement made between you (either as an individual or as an entity) and NEC Computers Asia Pacific Sdn. Bhd. (NECCAP). This Agreement covers all software that is distributed with NECCAP's product, for which there is no separate license agreement between you and the manufacturer or owner of the software (collectively referred to as "the Software"). By using the Software that has been pre-loaded or embedded in your product or installing or downloading the Software that is included with your product or opening the sealed software packet(s) you are agreeing to be bound by the terms of this Agreement. If you do not agree to the terms of this Agreement, promptly return the unopened software packet(s) and the accompanying items (including but not limited to the written materials and binders or other packages) to the place you obtained them and delete any preloaded or embedded software.

NECCAP SOFTWARE LICENSE

GRANT OF LICENSE

You are permitted to use one copy of the specified version of the NECCAP CD-ROM product identified above on any single computer, provided the Software is in use on only one computer at any time. If you have multiple licenses for the Software, then at any time, you may have as many copies of the Software in use as you have licenses. The Software is 'in use' on a computer when it is loaded into the temporary memory (i.e. RAM) or installed in the permanent memory (e.g. hard disk, CD-ROM, or other storage device of that computer). A copy of Software installed on a network server for the sole purpose of distribution to other computers is not 'in use' if you have a separate license for each computer to which the Software is distributed. You must ensure that, you have purchased additional licenses until the number of licenses is equivalent to the number of users before allowing the users to use the Software. If you are a commercial customer of NECCAP, you hereby irrevocably grant NECCAP the right to perform an audit of your use of the Software during normal hours, you agree to cooperate with NECCAP in such audit and you agree to provide NECCAP with all records related to the use of the Software. Such audit is strictly for the purpose of confirmation of your compliance with the terms of this Agreement.

COPYRIGHT

The Software is owned by NECCAP or its suppliers and is protected by United States copyright laws and international treaty provision. Therefore, you must treat the Software like any other copyrighted material (e.g. a book or musical recording) except that you may either (a) make one copy of the floppy disk portion of the Software, if solely for backup or archival purposes, or (b) for the transfer of the floppy disk portion of the Software to a single hard disk provided you keep the original solely for backup or archival purposes. You may not copy the CD-ROM disc portion of the Software or the written materials accompanying the Software.

OTHER RESTRICTIONS

You may not rent or lease the Software, but you may transfer the Software and accompanying written materials on a permanent basis provided you retain no copies and the recipient agrees to the terms of this Agreement. You may not reverse, engineer, decompile or disassemble the Software. Any transfer of the Software must include the most recent update and all prior versions.

You may not use the disks on another computer or network, or loan, rent, lease or transfer them to another use except as permitted by this Agreement.

LIMITED WARRANTY

LIMITED WARRANTY

The Software is distributed and licensed "AS IS", with no warranties whatsoever, express or implied permissible under the law. NECCAP warrants that the media containing the Software is free from defects in material and workmanship for a period of time (please refer to your warranty card/guide) from the date you receive the Software. Any hardware accompanying the Software, shall be limited to NECCAP's then-current hardware limited warranty. Due to the complex nature of computer software, NECCAP and its suppliers do not warrant that the Software is completely error free, will operate without interruption, or is compatible with all equipment and software configurations. You expressly assume all risk for use of Software or program. This limited warranty is solely for your own benefit and shall not be transferred or assigned in any manner whatsoever.

NOT COVERED

This warranty does not cover technical assistance for software training and usage whatsoever.

CUSTOMER REMEDIES

During the warranty period NECCAP and its suppliers' entire liability and your customer rights shall be, at NECCAP's discretion, repair or replacement of the Software that does not meet this Limited Warranty and which is returned to NECCAP with a dated proof of purchase and authorisation number to NECCAP at your own cost, risk and expense. If dated proof of purchase is not provided, NECCAP's authorised service provider will not render service or may charge the customer for the service(s) performed. This limited warranty is void if product failure has resulted from accident, abuse, misuse or misapplication.

NO OTHER WARRANTIES

NECCAP and its suppliers' disclaim all other warranties, either express or implied including, but not limited to expressed or implied warranties of merchantability and fitness for a particular purpose with regards to the Software and the accompanying written materials. This limited warranty gives you specific legal rights. You may have other rights which vary from jurisdiction to jurisdiction.

NO LIABILITY FOR CONSEQUENTIAL DAMAGES

In no event shall NECCAP or its suppliers be liable for any damages whatsoever (including without limitation, damages for loss of business profits, business interruption, loss of business information, or any other pecuniary loss) arising out of the use or an inability to use this product, even if NECCAP or its suppliers has been advised of the possibility of such damages. Because some states/countries do not allow the exclusion or limitation of liability for consequential or incidental damages, the above limitation may not apply to you.

Copyright

Copyright

Notebook Electronic User's Guide, NEC VERSA P8510 Series 1.0 version, 10/2008.

Copyright © 2008, NEC Computers Asia Pacific Sdn Bhd (418989-A) ("NECCAP").

This guide and all software described in it are copyrighted with all rights reserved. No part of this manual may be reproduced or transmitted, in any form or by any means, whether electronic, chemical, manual or otherwise, including but not limited to photocopying, recording, or information storage and retrieval systems, for any purpose without prior written permission of NECCAP.

Disclaimer

NECCAP specifically disclaims all warranties, either expressed or implied, including, but not limited to, implied warranties of merchantability and fitness for a particular purpose with respect to this product and documentation to the extent permitted by the law. NECCAP reserves the right to revise or make changes or improvements to this product or documentation at any time without any obligation to notify any person or user of such revisions or improvements.

In no event shall NECCAP be liable for any consequential or incidental damages, including but not limited to loss of business profits or any other commercial damages, arising out of the use of this product.

Trademarks

NEC VERSA is a registered trademark of NEC Corporation, used under license.

Celeron, Celeron Inside, Centrino, Centrino Inside, Centrino Logo, Core Inside, Intel, Intel Logo, Intel Core, Intel Inside, Intel Inside Logo, Intel Viiv, Intel vPro, Itanium, Itanium Inside, Pentium, Pentium Inside, Viiv Inside, vPro Inside, Xeon, and Xeon Inside are trademarks of Intel Corporation in the U.S. and other countries.

Microsoft®, Encarta, MSN, Windows®, Microsoft® Outlook, Microsoft® Office logo and Windows® logo are either registered trademarks or trademarks of ©2008 Microsoft Corporation in the United States and/or other countries. Windows Vista® is either a registered trademark or trademark of ©2008 Microsoft Corporation in the United States and/or other countries.

The *Bluetooth*® word mark and logos are registered trademarks owned by Bluetooth SIG, Inc. and any use of such marks by NEC Corporation is under license. Other trademarks and trade names are those of their respective owners.

HDMI, the HDMI logo and High-Definition Multimedia Interface are trademarks or registered trademarks of HDMI Licensing LLC.

SRS Premium Sound, SRS and the (●)® symbol are trademarks of SRS Labs, Inc. (For specific models only).



This product is ENERGY STAR qualified and meets ENERGY STAR requirement, should you find there is an Energy Star certification mark on it.

Other product names mentioned in this reference may be trademarks or registered trademarks of their respective companies. NECCAP claims no interest in trademarks other than its own.

Official Name of the Software Used

(Notation)	(Official Name)
Windows, Windows Vista	Windows Vista® Home Basic Windows Vista® Home Premium Windows Vista® Business Windows Vista® Ultimate
Internet Explorer	Windows® Internet Explorer®
Windows Media Center	Windows® Media Center